

# OMRON

## Digital Indicators

### K3HB Series

Distinct by Design,  
Distinguished in Performance



*DeviceNet*



K3HB-H



K3HB-S



K3HB-X



K3HB-V

**Innovation  
in the Solution Age**

OMRON INDUSTRIAL AUTOMATION

# Features

## Red-Green Display Allows Easy Recognition of Judgment Results

- The measurement value display can be set to switch between red and green in accordance with the status of comparative outputs. This means that the status can be ascertained at a distance.

## Position Meter Enables Easy Monitoring of Operating Status Trends

- The present value with respect to the measurement or display range (full scale) can be viewed on a bar display. The operating status can be grasped intuitively, allowing easy judgement of levels and threshold values.

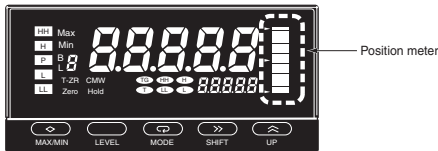

## Many Measurement and Discrimination Functions Using External Event Input

- Offers a wide variety of application possibilities, such detection and judgement while synchronizing on an external signal.

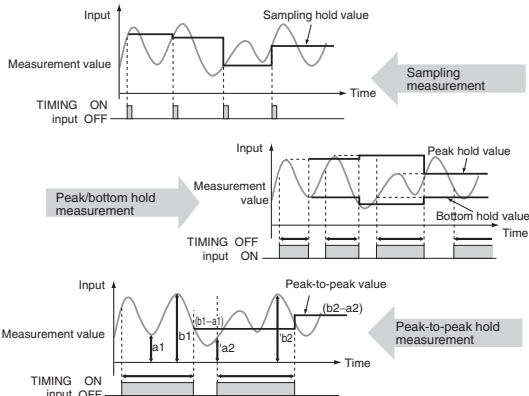

## High-speed Sampling at 50 Times per Second (20 ms)

- Provides an input sampling cycle at least three times faster than earlier models (12.5 times faster for temperature input models) at 50 times/second (see note). In addition to improved response times for judgement output and transfer output, average processing can be used to increase the stability of measurements.

**Note:** The K3HB-S Linear Sensor Indicator features high-speed response of 2,000 times/second.

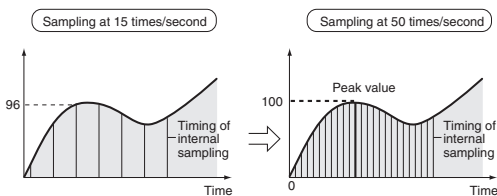

## Short Body with Depth of Only 95 mm (from Behind the Front Panel)

- A short body of only 95 mm (see note) contributes to the development of slimmer and smaller control panels and installations.

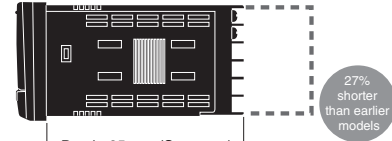

(The depth is 100 mm when mounted to the terminal cover.)

**Note:** Depth of DeviceNet models is 97 mm.

## Select a Comparative Output Pattern to Suit the Discrimination or Control Application

- The output pattern for comparative outputs can be selected. In addition to high/low comparison with set values, output based on level changes is also possible. (Use the type of output pattern appropriate for the application.)

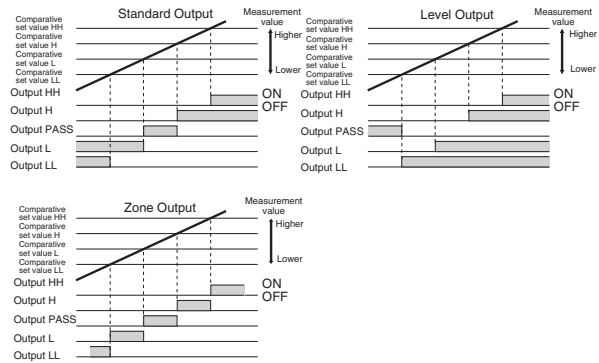

**Note:** The HH, H, L, or LL outputs must be set in that order for the zone outputs to output correctly. (This is because the comparative set values and outputs for standard and level outputs are in a 1-to-1 relationship, whereas the meaning of zone outputs depends on the settings of all the comparative set values.)

## Lineup Includes DeviceNet Models Enabling High-speed Data Communications with PLCs without Special Programming

- DeviceNet compliance enables high-speed data transmission by allocating setting and monitoring parameters in the I/O memory of the PLC. This capability greatly reduces labor spent in developing communications programs.

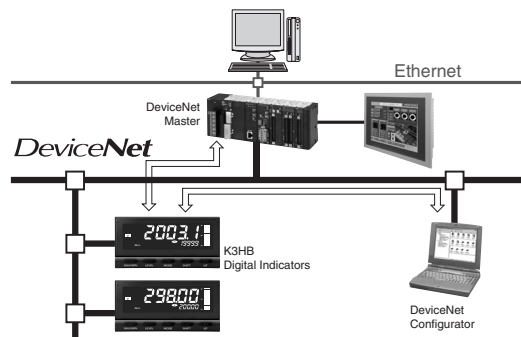

**Note:** The applications provided in this catalog are intended as reference only. Do not attempt to use any of them in real systems without first confirming machine and device functions and safety. For applications that require safety, ensure that there is sufficient leeway in ratings and performances, install fail-safe measures, and take any other safety measures required by the application. In addition, contact your nearest OMRON representative and confirm specifications.

# K3HB-series Product Lineup

## ■ K3HB-X Process Indicator (page 4)

Indicates Measurements for Voltage/Current Signals



- DC Voltage Input Type: K3HB-XVD  
(±199.99 V, ±19.999 V, ±1.9999 V, 1.0000 to 5.0000 V)
- DC Current Input Type: K3HB-XAD  
(±199.99 mA, ±19.999 mA, ±1.9999 mA, 4.000 to 20.000 mA)
- AC Voltage Input Type: K3HB-XVA  
(0.0 to 400.0 V, 0.00 to 199.99 V, 0.0000 to 1.9999 V)
- AC Current Input Type: K3HB-XAA  
(0.000 to 10.000 A, 0.0000 to 1.9999 A, 0.00 to 199.99 mA, 0.000 to 19.999 mA)

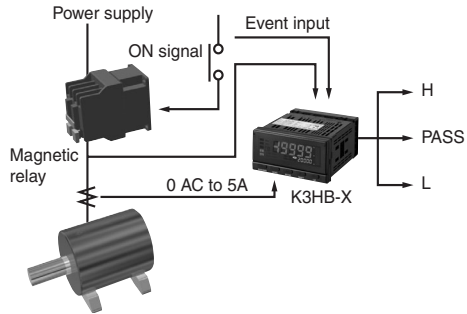

## ■ K3HB-V Weighing Indicator (page 8)

Indicates Weight Measurements Using a Load Cell



- K3HB-VLC  
(0.00 to 199.99 mV, 0.000 to 19.999 mV, ±100.00 mV, ±199.99 mV)

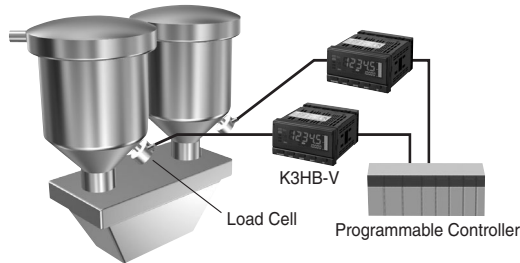

## ■ K3HB-H Temperature Indicator (page 12)

Indicates Temperature Measurements



- K3HB-HTA  
Platinum-resistance thermometer (Pt100: 2 ranges)  
Thermocouple (K: 2 ranges, J: 2 ranges, T, E, L, U, N, R, S, B, W)

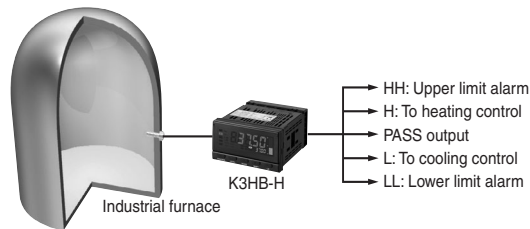

## ■ K3HB-S Linear Sensor Indicator (page 16)

Measures and Discriminates Results at High Speed with High Accuracy



- K3HB-SSD  
0.000 to 20.000 mA, 4.000 to 20.000 mA, 0.000 to 5.000 V, 1.000 to 5.000 V, ±5.000 V, ±10.000 V, two-channel input

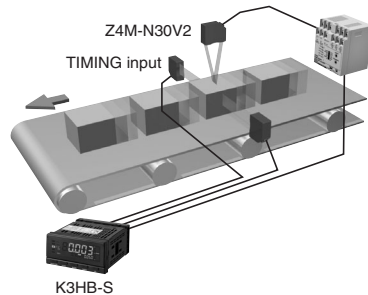

# Process Indicator K3HB-X

## A Process Indicator Ideal for Discriminating and Displaying Measurements for Voltage/Current Signals

- Easy recognition of judgement results using color display that can be switched between red and green.
- Equipped with a position meter for monitoring operating status trends.
- External event input allows use in various measurement and discrimination applications.
- Series expanded to include DeviceNet models.
- Short body with depth of only 95 mm (from behind the front panel), or 97 mm for DeviceNet models.
- UL certification approval (Certification Mark License).
- CE Marking conformance by third party assessment body.
- Water-resistant enclosure conforms to NEMA 4X (equivalent to IP66).
- Capable of high-speed sampling at 50 times per second (20 ms)
- Easy-to-set two-point scaling allows conversion and display of any user-set values.



 Refer to *Precautions* on page 30.

## Model Number Structure

### Model Number Legend

Base Units and Optional Boards can be ordered individually or as sets.

#### Base Units

K3HB-X    
1 5

#### 1. Input Sensor Codes

VD: DC voltage input  
AD: DC current input  
VA: AC voltage input  
AA: AC current input

#### 5. Supply Voltage

100-240 VAC: 100 to 240 VAC  
24 VAC/VDC: 24 VAC/VDC

### Optional Board

#### Sensor Power Supply/Output Boards

K33-  
2

#### Relay/Transistor Output Boards

K34-  
3

#### Event Input Boards

K35-  
4

**Note:** 1. CPA can be combined with relay outputs only.

2. Only one of the following can be used by each Digital Indicator:  
RS-232C/RS-485 communications, a linear output, or DeviceNet communications.

### Accessories (Sold Separately)

K32-DICN: Special Cable (for event inputs, with 8-pin connector)  
K32-BCD: Special BCD Output Cable

#### Base Units with Optional Boards

K3HB-X       
1 2 3 4 5

#### 2. Sensor Power Supply/Output Type Codes

None: None  
CPA: Relay output (PASS: SPDT) + Sensor power supply  
(12 VDC +/-10%, 80 mA) (See note 1.)  
L1A: Linear current output (DC0(4) – 20 mA) + Sensor power supply  
(12 VDC +/-10%, 80 mA) (See note 2.)  
L2A: Linear voltage output (DC0(1) – 5 V, 0 to 10 V) + Sensor power supply  
(12 VDC +/-10%, 80 mA) (See note 2.)  
A: Sensor power supply (12 VDC +/-10%, 80 mA)  
FLK1A: Communications (RS-232C) + Sensor power supply  
(12 VDC +/-10%, 80 mA) (See note 2.)  
FLK3A: Communications (RS-485) + Sensor power supply  
(12 VDC +/-10%, 80 mA) (See note 2.)

#### 3. Relay/Transistor Output Type Codes

None: None  
C1: Relay contact (H/L: SPDT each)  
C2: Relay contact (HH/H/LL/L: SPST-NO each)  
T1: Transistor (NPN open collector: HH/H/PASS/L/LL)  
T2: Transistor (PNP open collector: HH/H/PASS/L/LL)  
BCD: BCD output + transistor output (NPN open collector: HH/H/PASS/L/LL)  
DRT: DeviceNet (See note 2.)

#### 4. Event input Type Codes

None: None  
1: 5 points (M3 terminal blocks) NPN open collector  
2: 8 points (10-pin MIL connector) NPN open collector  
3: 5 points (M3 terminal blocks) PNP open collector  
4: 8 points (10-pin MIL connector) PNP open collector

# Specifications

## ■ Ratings

<b>Power supply voltage</b>		100 to 240 VAC (50/60 Hz), 24 VAC/VDC, DeviceNet power supply: 24 VDC
<b>Allowable power supply voltage range</b>		85% to 110% of the rated power supply voltage, DeviceNet power supply: 11 to 25 VDC
<b>Power consumption (See note 1.)</b>		100 to 240 V: 18 VA max. (max. load) 24 VAC/DC: 11 VA/7 W max. (max. load)
<b>Current consumption</b>		DeviceNet power supply: 50 mA max. (24 VDC)
<b>Input</b>		DC voltage, DC current, AC voltage, AC current
<b>A/D conversion method</b>		Delta-Sigma method
<b>External power supply</b>		See Sensor Power Supply/Output Type Codes
<b>Event inputs (See note 2.)</b>	<b>Timing input</b>	NPN open collector or no-voltage contact signal ON residual voltage: 3 V max. ON current at 0 Ω: 17 mA max. Max. applied voltage: 30 VDC max. OFF leakage current: 1.5 mA max.
	<b>Startup compensation timer input</b>	NPN open collector or no-voltage contact signal ON residual voltage: 2 V max.
	<b>Hold input</b>	ON current at 0 Ω: 4 mA max.
	<b>Reset input</b>	Max. applied voltage: 30 VDC max.
	<b>Forced-zero input</b>	OFF leakage current: 0.1 mA max.
<b>Output ratings (depends on the model)</b>	<b>Relay output</b>	250 VAC, 30 VDC, 5 A (resistive load) Mechanical life expectancy: 5,000,000 operations, Electrical life expectancy: 100,000 operations
	<b>Transistor output</b>	Maximum load voltage: 24 VDC, Maximum load current: 50 mA, Leakage current: 100 μA max.
	<b>Linear output</b>	Linear output 0 to 20 mA DC, 4 to 20 mA: Load: 500 Ω max, Resolution: Approx. 10,000, Output error: ±0.5% FS Linear output 0 to 5 VDC, 1 to 5 VDC, 0 to 10 VDC: Load: 5 kΩ max, Resolution: Approx. 10,000, Output error: ±0.5% FS (1 V or less: ±0.15 V; not output for 0 V or less)
<b>Display method</b>		Negative LCD (backlit LED) display 7-segment digital display (Character height: PV: 14.2 mm (green/red); SV: 4.9 mm (green))
<b>Main functions</b>		Scaling function, measurement operation selection, averaging, previous average value comparison, forced-zero, zero-limit, output hysteresis, output OFF delay, output test, teaching, display value selection, display color selection, key protection, bank selection, display refresh period, maximum/minimum hold, reset
<b>Ambient operating temperature</b>		-10 to 55°C (with no icing or condensation)
<b>Ambient operating humidity</b>		25% to 85%
<b>Storage temperature</b>		-25 to 65°C (with no icing or condensation)
<b>Altitude</b>		2,000 m max.
<b>Accessories</b>		Watertight packing, 2 fixtures, terminal cover, unit stickers, instruction manual. DeviceNet models also include a DeviceNet connector (Hirose HR31-5.08P-5SC(01)) and crimp terminals (Hirose HR31-SC-121) (See note 3.)

**Note:** 1. DC power supply models require a control power supply capacity of approximately 1 A per Unit when power is turned ON. Particular attention is required when using two or more DC power supply models. The OMRON S8VS-series DC Power Supply Unit is recommended.

2. PNP input types are also available.

3. For K3HB-series DeviceNet models, use only the DeviceNet Connector included with the product. The crimp terminals provided are for Thin Cables.

## ■ Characteristics

<b>Display range</b>		-19,999 to 99,999
<b>Sampling period</b>		20 ms (50 times/second)
<b>Comparative output response time</b>		DC input: 100 ms max.; AC input: 300 ms max.
<b>Linear output response time</b>		DC input: 150 ms max.; AC input: 420 ms max.
<b>Insulation resistance</b>		20 MΩ min. (at 500 VDC)
<b>Dielectric strength</b>		2,300 VAC for 1 min between external terminals and case
<b>Noise immunity</b>		100 to 240 VAC models: ±1,500 V at power supply terminals in normal or common mode (waveform with 1-ns rising edge and pulse width of 1 μs/100 ns) 24 VAC/VDC models: ±1,500 V at power supply terminals in normal or common mode (waveform with 1-ns rising edge and pulse width of 1 μs/100 ns)
<b>Vibration resistance</b>		Frequency: 10 to 55 Hz; Acceleration: 50 m/s <sup>2</sup> , 10 sweeps of 5 min each in X, Y, and Z directions
<b>Shock resistance</b>		150 m/s <sup>2</sup> (100 m/s <sup>2</sup> for relay outputs) 3 times each in 3 axes, 6 directions
<b>Weight</b>		Approx. 300 g (Base Unit only)
<b>Degree of protection</b>	<b>Front panel</b>	Conforms to NEMA 4X for indoor use (equivalent to IP66)
	<b>Rear case</b>	IP20
	<b>Terminals</b>	IP00 + finger protection (VDE0106/100)
<b>Memory protection</b>		EEPROM (non-volatile memory) Number of rewrites: 100,000
<b>Applicable standards</b>		UL61010C-1, CSA C22.2 No. 1010.1 (evaluated by UL) EN61010-1 (IEC61010-1): Pollution degree 2/Overvoltage category II EN61326: 1997, A1: 1998, A2: 2001
<b>EMC</b>		EMI: EN61326+A1 industrial applications Electromagnetic radiation interference CISPR 11 Group 1, Class A: CISPR16-1/-2 Terminal interference voltage CISPR 11 Group 1, Class A: CISPR16-1/-2 EMS: EN61326+A1 industrial applications Electrostatic Discharge Immunity EN61000-4-2: 4 kV (contact), 8 kV (in air) Radiated Electromagnetic Field Immunity EN61000-4-3: 10 V/m 1 kHz sine wave amplitude modulation (80 MHz to 1 GHz) Electrical Fast Transient/Burst Immunity EN61000-4-4: 2 kV (power line), 1 kV (I/O signal line) Surge Immunity EN61000-4-5: 1 kV with line (power line), 2 kV with ground (power line) Conducted Disturbance Immunity EN61000-4-6: 3 V (0.15 to 80 MHz) Voltage Dips and Interruptions Immunity EN61000-4-11: 0.5 cycle, 0°/180°, 100% (rated voltage)

## Input Range (Measurement Range and Accuracy) CAT II

Input type	Range	Set value	Measurement range	Input impedance	Accuracy	Allowable instantaneous overload (30 s)
K3HB-XVD DC voltage	A	$R \ u d$	$\pm 199.99 \text{ V}$	10 M $\Omega$ min.	$\pm 0.1\% \text{rdg} \pm 1$ digit max.	$\pm 400 \text{ V}$
	B	$b \ u d$	$\pm 19.999 \text{ V}$	1 M $\Omega$ min.		$\pm 200 \text{ V}$
	C	$\bar{c} \ u d$	$\pm 1.9999 \text{ V}$			
	D	$d \ u d$	1.0000 to 5.0000 V			
K3HB-XAD DC current	A	$R \ R d$	$\pm 199.99 \text{ mA}$	1 $\Omega$ max.	$\pm 0.1\% \text{rdg} \pm 1$ digit max.	$\pm 400 \text{ mA}$
	B	$b \ R d$	$\pm 19.999 \text{ mA}$	10 $\Omega$ max.		$\pm 200 \text{ mA}$
	C	$\bar{c} \ R d$	$\pm 1.9999 \text{ mA}$	33 $\Omega$ max.		
	D	$d \ R d$	4.000 to 20.000 mA	10 $\Omega$ max.		
K3HB-XVA AC voltage (See note 4.)	A	$R \ u R$	0.0 to 400.0 V	1 M $\Omega$ min.	$\pm 0.3\% \text{rdg} \pm 5$ digits max.	700 V
	B	$b \ u R$	0.00 to 199.99 V			400 V
	C	$\bar{c} \ u R$	0.000 to 19.999 V		$\pm 0.5\% \text{rdg} \pm 10$ digits max.	
	D	$d \ u R$	0.0000 to 1.9999 V			
K3HB-XAA AC current	A	$R \ R R$	0.000 to 10.000 A	(0.5 VA CT) (See note 3.)	$\pm 0.5\% \text{rdg} \pm 20$ digits max.	20 A
	B	$b \ R R$	0.0000 to 1.9999 A	(0.5 VA CT) (See note 3.)		
	C	$\bar{c} \ R R$	0.00 to 199.99 mA	1 $\Omega$ max.	$\pm 0.5\% \text{rdg} \pm 10$ digits max.	2 A
	D	$d \ R R$	0.000 to 19.999 mA	10 $\Omega$ max.		

**Note: 1.** The accuracy is for an input frequency range of 40 Hz to 1 kHz (except for AD current input A and B ranges) and an ambient temperature of 23  $\pm 5^\circ\text{C}$ . The error, however, increases below 10% of the maximum input value.

DC voltage input (all ranges): 10% or less of max. input =  $\pm 0.15\% \text{ FS}$

DC current input (all ranges): 10% or less of max. input =  $\pm 0.1\% \text{ FS}$

AC voltage input (A: 0.0 to 400.0 V): 10% or less of max. input =  $\pm 0.15\% \text{ FS}$

AC voltage input (B: 0.00 to 199.99 V): 10% or less of max. input =  $\pm 0.2\% \text{ FS}$

AC voltage input (C: 0.000 to 19.999 V; D: 0.0000 to 1.9999 V): 10% or less of max. input =  $\pm 1.0\% \text{ FS}$

AC current input (A: 0.000 to 10.000 A): 10% or less of max. input =  $\pm 0.25\% \text{ FS}$

AC current input (B: 0.0000 to 1.9999 A): 10% or less of max. input =  $\pm 0.5\% \text{ FS}$

AC current input, (C: 0.00 to 199.99 mA; D: 0.000 to 19.999 A): 10% or less of max. input =  $\pm 0.15\% \text{ FS}$

When DC voltage input models are used with a  $\pm 1.9999 \text{ V}$  range, make sure that the connections between input terminals are not open. If the input terminals are open, the display will show large variations. Connect resistance of approximately 1 M $\Omega$  between the input terminals if they are open.

- The letters "rdg" mean "reading" and refer to the input error.
- The value (0.5 VA CT) is the VA consumption of the internal CT (current transformer).

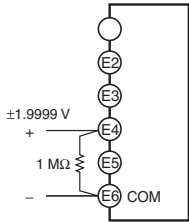

- The K3HB-XVA□□ complies with UL standards when the applied input voltage is within the range 0 to 150 VAC. If the input voltage is higher than 150 VAC, install an external transformer or take other measures to drop the voltage to 150 VAC or lower.

# Weighing Indicator K3HB-V

**An Ideal Indicator for OK/NG Judgements in Automated and Picking Machines, Measuring Factors such as Pressure, Load, Torque, and Weight Using Load Cell Signal Input.**

- Easy recognition of judgement results using color display that can be switched between red and green.
- Equipped with a position meter for monitoring operating status trends.
- External event input allows use in various measurement and discrimination applications.
- Series expanded to include DeviceNet models.
- Short body with depth of only 95 mm (from behind the front panel), or 97 mm for DeviceNet models.
- UL certification approval (Certification Mark License).
- CE Marking conformance by third party assessment body.
- Water-resistant enclosure conforms to NEMA 4X (equivalent to IP66).
- Capable of high-speed sampling at 50 times per second (20 ms)
- Easy-to-set two-point scaling allows conversion and display of any user-set values.



Refer to *Precautions on page 30.*

## Model Number Structure

### Model Number Legend

Base Units and Optional Boards can be ordered individually or as sets.

#### Base Units

K3HB-V    
1 5

##### 1. Input Sensor Codes

LC: Load cell input (DC low-voltage input)

##### 5. Supply Voltage

100-240 VAC: 100 to 240 VAC  
24 VAC/VDC: 24 VAC/VDC

#### Optional Board

##### Sensor Power Supply/Output Boards

K33-  
2

##### Relay/Transistor Output Boards

K34-  
3

##### Event Input Boards

K35-  
4

**Note:** 1. CPB can be combined with relay outputs only.

2. Only one of the following can be used by each Digital Indicator:  
RS-232C/RS-485 communications, a linear output, or DeviceNet communications.

### Accessories (Sold Separately)

K32-DICN: Special Cable (for event inputs, with 8-pin connector)  
K32-BCD: Special BCD Output Cable

#### Base Units with Optional Boards

K3HB-V       
1 2 3 4 5

##### 2. Sensor Power Supply/Output Type Codes

- None: None
- CPB: Relay output (PASS: SPDT) + Sensor power supply (10 VDC +/-5%, 100 mA) (See note 1.)
- L1B: Linear current output (DC0(4) – 20 mA) + Sensor power supply (10 VDC +/-5%, 100 mA) (See note 2.)
- L2B: Linear voltage output (DC0(1) – 5 V, 0 to 10 V) + Sensor power supply (10 VDC +/-5%, 100 mA) (See note 2.)
- B: Sensor power supply (10 VDC +/-5%, 100 mA)
- FLK1B: Communications (RS-232C) + Sensor power supply (10 VDC +/-5%, 100 mA) (See note 2.)
- FLK3B: Communications (RS-485) + Sensor power supply (10 VDC +/-5%, 100 mA) (See note 2.)

##### 3. Relay/Transistor Output Type Codes

- None: None
- C1: Relay contact (H/L: SPDT each)
- C2: Relay contact (HH/H/LL/L: SPST-NO each)
- T1: Transistor (NPN open collector: HH/H/PASS/L/LL)
- T2: Transistor (PNP open collector: HH/H/PASS/L/LL)
- BCD: BCD output + transistor output (NPN open collector: HH/H/PASS/L/LL)
- DRT: DeviceNet (See note 2.)

##### 4. Event input Type Codes

- None: None
- 1: 5 points (M3 terminal blocks) NPN open collector
- 2: 8 points (10-pin MIL connector) NPN open collector
- 3: 5 points (M3 terminal blocks) PNP open collector
- 4: 8 points (10-pin MIL connector) PNP open collector



# Specifications

## ■ Ratings

<b>Power supply voltage</b>		100 to 240 VAC (50/60 Hz), 24 VAC/VDC, DeviceNet power supply: 24 VDC
<b>Allowable power supply voltage range</b>		85% to 110% of the rated power supply voltage, DeviceNet power supply: 11 to 25 VDC
<b>Power consumption (See note 1.)</b>		100 to 240 V: 18 VA max. (max. load) 24 VAC/DC: 11 VA/7 W max. (max. load)
<b>Current consumption</b>		DeviceNet power supply: 50 mA max. (24 VDC)
<b>Input</b>		DC voltage
<b>A/D conversion method</b>		Delta-Sigma method
<b>External power supply</b>		See Sensor Power Supply/Output Type Codes
<b>Event inputs (See note 2.)</b>	<b>Timing input</b>	NPN open collector or no-voltage contact signal ON residual voltage: 3 V max. ON current at 0 Ω: 17 mA max. Max. applied voltage: 30 VDC max. OFF leakage current: 1.5 mA max.
	<b>Startup compensation timer input</b>	NPN open collector or no-voltage contact signal ON residual voltage: 2 V max. ON current at 0 Ω: 4 mA max. Max. applied voltage: 30 VDC max. OFF leakage current: 0.1 mA max.
	<b>Hold input</b>	
	<b>Reset input</b>	
	<b>Forced-zero input</b>	
	<b>Bank input</b>	
<b>Output ratings (depends on the model)</b>	<b>Relay output</b>	250 VAC, 30 VDC, 5 A (resistive load) Mechanical life expectancy: 5,000,000 operations, Electrical life expectancy: 100,000 operations
	<b>Transistor output</b>	Maximum load voltage: 24 VDC, Maximum load current: 50 mA, Leakage current: 100 μA max.
	<b>Linear output</b>	Linear output 0 to 20 mA DC, 4 to 20 mA: Load: 500 Ω max, Resolution: Approx. 10,000, Output error: ±0.5% FS Linear output 0 to 5 VDC, 1 to 5 VDC, 0 to 10 VDC: Load: 5 kΩ max, Resolution: Approx. 10,000, Output error: ±0.5% FS (1 V or less: ±0.15 V; not output for 0 V or less)
<b>Display method</b>		Negative LCD (backlit LED) display 7-segment digital display (Character height: PV: 14.2 mm (green/red); SV: 4.9 mm (green))
<b>Main functions</b>		Scaling function, measurement operation selection, averaging, previous average value comparison, forced-zero, zero-limit, output hysteresis, output OFF delay, output test, teaching, display value selection, display color selection, key protection, bank selection, display refresh period, maximum/minimum hold, reset
<b>Ambient operating temperature</b>		-10 to 55°C (with no icing or condensation)
<b>Ambient operating humidity</b>		25% to 85%
<b>Storage temperature</b>		-25 to 65°C (with no icing or condensation)
<b>Altitude</b>		2,000 m max.
<b>Accessories</b>		Watertight packing, 2 fixtures, terminal cover, unit stickers, operation manual. DeviceNet models also include a DeviceNet connector (Hirose HR31-5.08P-5SC(01)) and crimp terminals (Hirose HR31-SC-121) (See note 3.)

**Note:** 1. DC power supply models require a control power supply capacity of approximately 1 A per Unit when power is turned ON. Particular attention is required when using two or more DC power supply models. The OMRON S8VS-series DC Power Supply Unit is recommended.

2. PNP input types are also available.

3. For K3HB-series DeviceNet models, use only the DeviceNet Connector included with the product. The crimp terminals provided are for Thin Cables.

## ■ Characteristics

<b>Display range</b>	-19,999 to 99,999	
<b>Sampling period</b>	20 ms (50 times/second)	
<b>Comparative output response time</b>	100 ms max.	
<b>Linear output response time</b>	150 ms max.	
<b>Insulation resistance</b>	20 MΩ min. (at 500 VDC)	
<b>Dielectric strength</b>	2,300 VAC for 1 min between external terminals and case	
<b>Noise immunity</b>	100 to 240 VAC models: ±1,500 V at power supply terminals in normal or common mode (waveform with 1-ns rising edge and pulse width of 1 μs/100 ns) 24 VAC/VDC models: ±1,500 V at power supply terminals in normal or common mode (waveform with 1-ns rising edge and pulse width of 1 μs/100 ns)	
<b>Vibration resistance</b>	Frequency: 10 to 55 Hz; Acceleration: 50 m/s <sup>2</sup> , 10 sweeps of 5 min each in X, Y, and Z directions	
<b>Shock resistance</b>	150 m/s <sup>2</sup> (100 m/s <sup>2</sup> for relay outputs) 3 times each in 3 axes, 6 directions	
<b>Weight</b>	Approx. 300 g (Base Unit only)	
<b>Degree of protection</b>	<b>Front panel</b>	Conforms to NEMA 4X for indoor use (equivalent to IP66)
	<b>Rear case</b>	IP20
	<b>Terminals</b>	IP00 + finger protection (VDE0106/100)
<b>Memory protection</b>	EEPROM (non-volatile memory) Number of rewrites: 100,000	
<b>Applicable standards</b>	UL61010C-1, CSA C22.2 No. 1010.1 (evaluated by UL) EN61010-1 (IEC61010-1): Pollution degree 2/Overvoltage category II EN61326: 1997, A1: 1998, A2: 2001	
<b>EMC</b>	EMI: EN61326+A1 industrial applications Electromagnetic radiation interference CISPR 11 Group 1, Class A: CISPRL16-1/-2 Terminal interference voltage CISPR 11 Group 1, Class A: CISPRL16-1/-2 EMS: EN61326+A1 industrial applications Electrostatic Discharge Immunity EN61000-4-2: 4 kV (contact), 8 kV (in air) Radiated Electromagnetic Field Immunity EN61000-4-3: 10 V/m 1 kHz sine wave amplitude modulation (80 MHz to 1 GHz) Electrical Fast Transient/Burst Immunity EN61000-4-4: 2 kV (power line), 1 kV (I/O signal line) Surge Immunity EN61000-4-5: 1 kV with line (power line), 2 kV with ground (power line) Conducted Disturbance Immunity EN61000-4-6: 3 V (0.15 to 80 MHz) Voltage Dips and Interruptions Immunity EN61000-4-11: 0.5 cycle, 0°/180°, 100% (rated voltage)	

## Input Ranges (Measurement Range and Accuracy)

Input type	Range	Set value	Measurement range	Input impedance	Accuracy	Allowable instantaneous overload (30 s)
K3HB-VLC Load Cell, mV	A	$R \ u d$	0.00 to 199.99 mV	1 M $\Omega$ min.	$\pm 0.1\%rdg \pm 1$ digit max.	$\pm 200$ V
	B	$b \ u d$	0.000 to 19.999 mV		$\pm 0.1\%rdg \pm 5$ digits max.	
	C	$l \ u d$	$\pm 100.00$ mV		$\pm 0.1\%rdg \pm 3$ digits max.	
	D	$d \ u d$	$\pm 199.99$ mV		$\pm 0.1\%rdg \pm 1$ digit max.	

**Note:** 1. The accuracy is for an ambient temperature of 23 $\pm$ 5 $^{\circ}$ C. For all ranges, 10% or less of max. input  $\pm 0.1\%$  FS.  
2. The letters "rdg" mean "reading."

Input type Connected terminals	$R \ l l$	$b \ l l$	$l \ l l$	$d \ l l$
	(E2) - (E6)	(E3) - (E6)	(E4) - (E6)	(E5) - (E6)
(mV)	199.99			199.99
200.000	[Dark shaded area from 0.00 to 199.99]			
150.000				
100.000				
50.000				
0.00				
-50.00	0.00	19.999	100.00	
-100.00		0.000		
-150.00			-100.00	
-200.00				-199.99

The area shown in dark shading indicates the factory setting.

## Load Cell Wiring Example

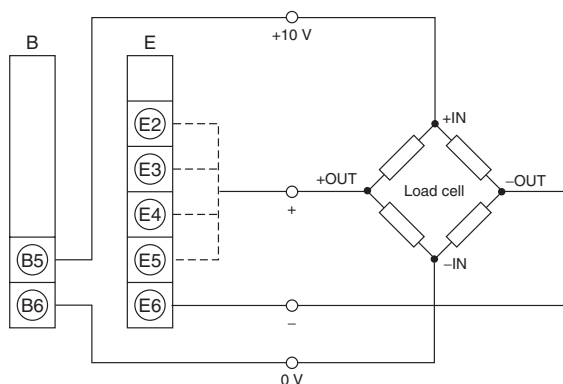

## Scaling Example Using Range A

Indicated on the K3HB-V as 0 to 49N in the load cell specifications (rated load 49N, recommended applied voltage 10 V, rated output 2 mV/V) (See note.)

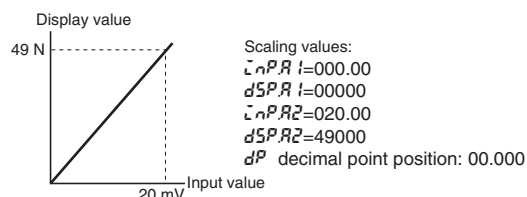

**Note:** 2 mV/V indicates a load cell output of 2 mV for 1 V applied voltage for the rated load (when using a load of 1 N). When the applied voltage is 10 V, the load cell output is 20 mV (2 mV  $\times$  10).

# Temperature Indicator K3HB-H

## New High-speed, High-precision Temperature Indicator

- Easy recognition of judgement results using color display that can be switched between red and green.
- Equipped with a position meter for monitoring operating status trends.
- External event input allows use in various measurement and discrimination applications.
- Series expanded to include DeviceNet models.
- Short body with depth of only 95 mm (from behind the front panel), or 97 mm for DeviceNet models.
- UL certification approval (Certification Mark License).
- CE Marking conformance by third party assessment body.
- Water-resistant enclosure conforms to NEMA 4X (equivalent to IP66).
- Capable of high-speed sampling at 50 times per second (20 ms).
- High-resolution of 0.01°C with platinum-resistance thermometer Pt100 input. Thermocouple sensor inputs also support a resolution of 0.1°C for all ranges.
- Temperature input shift is easily set using two points.



 Refer to *Precautions on page 30.*

## Model Number Structure

### Model Number Legend

Base Units and Optional Boards can be ordered individually or as sets.

#### Base Units

K3HB-H    
1 5

#### 1. Input Sensor Codes

- TA: Temperature input
- Thermocouple input/Platinum-resistance thermometer input

#### 5. Supply Voltage

- 100-240 VAC: 100 to 240 VAC
- 24 VAC/VDC: 24 VAC/VDC

### Optional Board

#### Sensor Power Supply/Output Boards

K33-  
2

#### Relay/Transistor Output Boards

K34-  
3

#### Event Input Boards

K35-  
4

**Note:** 1. CPA can be combined with relay outputs only.

- 2. Only one of the following can be used by each Digital Indicator:  
RS-232C/RS-485 communications, a linear output, or DeviceNet communications.

### Accessories (Sold Separately)

- K32-DICN: Special Cable (for event inputs, with 8-pin connector)
- K32-BCD: Special BCD Output Cable

#### Base Units with Optional Boards

K3HB-H       
1 2 3 4 5

#### 2. Sensor Power Supply/Output Type Codes

- None: None
- CPA: Relay output (PASS: SPDT) + Sensor power supply (12 VDC +/-10%, 80 mA) (See note 1.)
- L1A: Linear current output (DC0(4) – 20 mA) + Sensor power supply (12 VDC +/-10%, 80 mA) (See note 2.)
- L2A: Linear voltage output (DC0(1) – 5 V, 0 to 10 V) + Sensor power supply (12 VDC +/-10%, 80 mA) (See note 2.)
- A: Sensor power supply (12 VDC +/-10%, 80 mA)
- FLK1A: Communications (RS-232C) + Sensor power supply (12 VDC +/-10%, 80 mA) (See note 2.)
- FLK3A: Communications (RS-485) + Sensor power supply (12 VDC +/-10%, 80 mA) (See note 2.)

#### 3. Relay/Transistor Output Type Codes

- None: None
- C1: Relay contact (H/L: SPDT each)
- C2: Relay contact (HH/H/LL/L: SPST-NO each)
- T1: Transistor (NPN open collector: HH/H/PASS/L/LL)
- T2: Transistor (PNP open collector: HH/H/PASS/L/LL)
- BCD: BCD output + transistor output (NPN open collector: HH/H/PASS/L/LL)
- DRT: DeviceNet (See note 2.)

#### 4. Event input Type Codes

- None: None
- 1: 5 points (M3 terminal blocks) NPN open collector
- 2: 8 points (10-pin MIL connector) NPN open collector
- 3: 5 points (M3 terminal blocks) PNP open collector
- 4: 8 points (10-pin MIL connector) PNP open collector

# Specifications

## ■ Ratings

<b>Power supply voltage</b>		100 to 240 VAC (50/60 Hz), 24 VAC/VDC, DeviceNet power supply: 24 VDC
<b>Allowable power supply voltage range</b>		85% to 110% of the rated power supply voltage, DeviceNet power supply: 11 to 25 VDC
<b>Power consumption (See note 1.)</b>		100 to 240 V: 18 VA max. (max. load) 24 VAC/DC: 11 VA/7 W max. (max. load)
<b>Current consumption</b>		DeviceNet power supply: 50 mA max. (24 VDC)
<b>Input</b>		Platinum-resistance thermometer: Pt100 Thermocouple: K, J, T, E, L, U, N, R, S, B, W
<b>A/D conversion method</b>		Delta-Sigma method
<b>External power supply</b>		See Sensor Power Supply/Output Type Codes
<b>Event inputs (See note 2.)</b>	<b>Timing input</b>	NPN open collector or no-voltage contact signal ON residual voltage: 3 V max. ON current at 0 Ω: 17 mA max. Max. applied voltage: 30 VDC max. OFF leakage current: 1.5 mA max.
	<b>Startup compensation timer input</b>	NPN open collector or no-voltage contact signal ON residual voltage: 2 V max.
	<b>Hold input</b>	ON current at 0 Ω: 4 mA max. Max. applied voltage: 30 VDC max.
	<b>Reset input</b>	OFF leakage current: 0.1 mA max.
	<b>Bank input</b>	
<b>Output ratings (depends on the model)</b>	<b>Relay output</b>	250 VAC, 30 VDC, 5 A (resistive load) Mechanical life expectancy: 5,000,000 operations, Electrical life expectancy: 100,000 operations
	<b>Transistor output</b>	Maximum load voltage: 24 VDC, Maximum load current: 50 mA, Leakage current: 100 μA max.
	<b>Linear output</b>	Linear output 0 to 20 mA DC, 4 to 20 mA: Load: 500 Ω max, Resolution: Approx. 10,000, Output error: ±0.5% FS Linear output 0 to 5 VDC, 1 to 5 VDC, 0 to 10 VDC: Load: 5 kΩ max, Resolution: Approx. 10,000, Output error: ±0.5% FS (1 V or less: ±0.15 V; not output for 0 V or less)
<b>Display method</b>		Negative LCD (backlit LED) display 7-segment digital display (Character height: PV: 14.2 mm (green/red); SV: 4.9 mm (green))
<b>Main functions</b>		Scaling function, measurement operation selection, averaging, previous average value comparison, zero-limit, output hysteresis, output OFF delay, output test, display value selection, display color selection, key protection, bank selection, display refresh period, maximum/minimum hold, reset
<b>Ambient operating temperature</b>		-10 to 55°C (with no icing or condensation)
<b>Ambient operating humidity</b>		25% to 85%
<b>Storage temperature</b>		-25 to 65°C (with no icing or condensation)
<b>Altitude</b>		2,000 m max.
<b>Accessories</b>		Watertight packing, 2 fixtures, terminal cover, unit stickers, instruction manual. DeviceNet models also include a DeviceNet connector (Hirose HR31-5.08P-5SC(01)) and crimp terminals (Hirose HR31-SC-121) (See note 3.)

- Note:**
1. DC power supply models require a control power supply capacity of approximately 1 A per Unit when power is turned ON. Particular attention is required when using two or more DC power supply models. The OMRON S8VS-series DC Power Supply Unit is recommended.
  2. PNP input types are also available.
  3. For K3HB-series DeviceNet models, use only the DeviceNet Connector included with the product. The crimp terminals provided are for Thin Cables.

## ■ Characteristics

<b>Display range</b>	-19,999 to 99,999	
<b>Accuracy</b>	Thermocouple input: ( $\pm 0.3\%$ PV or $\pm 1^\circ\text{C}$ , whichever is larger) $\pm 1$ digit max. (See note.) Platinum resistance thermometer input: ( $\pm 0.2\%$ PV or $\pm 0.8^\circ\text{C}$ , whichever is larger) $\pm 1$ digit max.	
<b>Sampling period</b>	20 ms (50 times/second)	
<b>Comparative output response time</b>	Platinum-resistance thermometer input range: 120 ms max. Thermocouple input range: 180 ms max.	
<b>Linear output response time</b>	Platinum-resistance thermometer input range: 170 ms max. Thermocouple input range: 230 ms max.	
<b>Insulation resistance</b>	20 M $\Omega$ min. (at 500 VDC)	
<b>Dielectric strength</b>	2,300 VAC for 1 min between external terminals and case	
<b>Noise immunity</b>	100 to 240 VAC models: $\pm 1,500$ V at power supply terminals in normal or common mode (waveform with 1-ns rising edge and pulse width of 1 $\mu\text{s}/100$ ns) 24 VAC/VDC models: $\pm 1,500$ V at power supply terminals in normal or common mode (waveform with 1-ns rising edge and pulse width of 1 $\mu\text{s}/100$ ns)	
<b>Vibration resistance</b>	Frequency: 10 to 55 Hz; Acceleration: 50 m/s <sup>2</sup> , 10 sweeps of 5 min each in X, Y, and Z directions	
<b>Shock resistance</b>	150 m/s <sup>2</sup> (100 m/s <sup>2</sup> for relay outputs) 3 times each in 3 axes, 6 directions	
<b>Weight</b>	Approx. 300 g (Base Unit only)	
<b>Degree of protection</b>	<b>Front panel</b>	Conforms to NEMA 4X for indoor use (equivalent to IP66)
	<b>Rear case</b>	IP20
	<b>Terminals</b>	IP00 + finger protection (VDE0106/100)
<b>Memory protection</b>	EEPROM (non-volatile memory) Number of rewrites: 100,000	
<b>Applicable standards</b>	UL61010C-1, CSA C22.2 No. 1010.1 (evaluated by UL) EN61010-1 (IEC61010-1): Pollution degree 2/Overvoltage category II EN61326: 1997, A1: 1998, A2: 2001	
<b>EMC</b>	EMI: EN61326+A1 industrial applications Electromagnetic radiation interference CISPR 11 Group 1, Class A: CISPR16-1/-2 Terminal interference voltage CISPR 11 Group 1, Class A: CISPR16-1/-2 EMS: EN61326+A1 industrial applications Electrostatic Discharge Immunity EN61000-4-2: 4 kV (contact), 8 kV (in air) Radiated Electromagnetic Field Immunity EN61000-4-3: 10 V/m 1 kHz sine wave amplitude modulation (80 MHz to 1 GHz) Electrical Fast Transient/Burst Immunity EN61000-4-4: 2 kV (power line), 1 kV (I/O signal line) Surge Immunity EN61000-4-5: 1 kV with line (power line), 2 kV with ground (power line) Conducted Disturbance Immunity EN61000-4-6: 3 V (0.15 to 80 MHz) Voltage Dips and Interruptions Immunity EN61000-4-11: 0.5 cycle, 0°/180°, 100% (rated voltage)	

**Note:** K, T, N ( $-100^\circ\text{C}$  or less):  $\pm 2^\circ\text{C} \pm 1$  digit max.  
U, L:  $\pm 2^\circ\text{C} \pm 1$  digit max.  
B ( $400^\circ\text{C}$  max.): Nothing specified.  
R, S ( $200^\circ\text{C}$  max.):  $\pm 3^\circ\text{C} \pm 1$  digit max.  
W: ( $\pm 0.3\%$  PV or  $\pm 3^\circ\text{C}$  whichever is larger)  $\pm 1$  digit max.

## ■ Input Ranges

### Platinum-resistance Thermometer/Thermocouple

Input type	Platinum-resistance thermometer	Thermocouple														
Name	Pt100	K	J	T	E	L	U	N	R	S	B	W (W/Re 5-26)				
Connected terminals	(E4) – (E5) – (E6)	(E5) – (E6)														
Temperature range (°C)	2300 1800 1300 900 800 700 600 400 300 200 100 0 -100 -200	850.0 -200.0	150.0 -150.00	1300.0 -200.0	500.0 -20.0	850.0 -100.0	400.0 -20.0	400.0 -200.0	600.0 0.0	850.0 -100.0	400.0 -200.0	1300.0 -200.0	1700.0 0.0	1700.0 0.0	1800.0 100.0	2300.0 0.0
Setting code	0-Pt	1-Pt	2-K	3-K	4-J	5-J	6-T	7-E	8-L	9-U	10-N	11-R	12-S	13-B	14-W	
Minimum setting unit (comparative set value)	0.1°C	0.01°C	0.1°C													

The range shown in dark shading indicates the factory setting.

### Celsius/Fahrenheit Correlation Values and Setting/Specified Ranges

Input type	Setting range		Indication range	
	°C	°F	°C	°F
Pt100 (1)	-200.0 to 850.0	-300.0 to 1500.0	-305.0 to 955.0	-480.0 to 1680.0
Pt100 (2)	-150.00 to 150.00	-199.99 to 300.00	-180.00 to 180.00	-199.99 to 350.00
K (1)	-200.0 to 1300.0	-300.0 to 2300.0	-350.0 to 1450.0	-560.0 to 2560.0
K (2)	-20.0 to 500.0	0.0 to 900.0	-72.0 to 552.0	-90.0 to 990.0
J (1)	-100.0 to 850.0	-100.0 to 1500.0	-195.0 to 945.0	-260.0 to 1660.0
J (2)	-20.0 to 400.0	0.0 to 750.0	-62.0 to 442.0	-75.0 to 825.0
T	-200.0 to 400.0	-300.0 to 700.0	-260.0 to 460.0	-400.0 to 800.0
E	0.0 to 600.0	0.0 to 1100.0	-60.0 to 660.0	-110.0 to 1210.0
L	-100.0 to 850.0	-100.0 to 1500.0	-195.0 to 945.0	-260.0 to 1660.0
U	-200.0 to 400.0	-300.0 to 700.0	-260.0 to 460.0	-400.0 to 800.0
N	-200.0 to 1300.0	-300.0 to 2300.0	-350.0 to 1450.0	-560.0 to 2560.0
R	0.0 to 1700.0	0.0 to 3000.0	-170.0 to 1870.0	-300.0 to 3300.0
S	0.0 to 1700.0	0.0 to 3000.0	-170.0 to 1870.0	-300.0 to 3300.0
B	100.0 to 1800.0	300.0 to 3200.0	-70.0 to 1970.0	10.0 to 3490.0
W	0.0 to 2300.0	0.0 to 4100.0	-230.0 to 2530.0	-410.0 to 4510.0

# Linear Sensor Indicator K3HB-S

## A Linear Sensor Indicator Capable of High-speed Response at 2,000 Times per Second

- Effective for high-speed measurement and discrimination with a sampling period of 0.5 ms and output response time of 1 ms max.
- Easy recognition of judgement results using color display that can be switched between red and green.
- Equipped with a position meter that represents measured amounts and relative positions.
- Zero calibration can be performed easily with the forced zero function.
- Series expanded to include DeviceNet models.
- Short body with depth of only 95 mm (from behind the front panel), or 97 mm for DeviceNet models.
- UL certification approval (Certification Mark License).
- CE Marking conformance by third party assessment body.
- Water-resistant enclosure conforms to NEMA 4X (equivalent to IP66).



Refer to *Precautions on page 30.*

## Model Number Structure

### Model Number Legend

Base Units and Optional Boards can be ordered individually or as sets.

#### Base Units

K3HB-S    
1 5

#### 1. Input Sensor Codes

SD: DC Process input

#### 5. Supply Voltage

100-240 VAC: 100 to 240 VAC

24 VAC/VDC: 24 VAC/VDC

### Optional Board

#### Sensor Power Supply/Output Boards

K33-  
2

#### Relay/Transistor Output Boards

K34-  
3

#### Event Input Boards

K35-  
4

**Note:** 1. CPA can be combined with relay outputs only.

2. Only one of the following can be used by each Digital Indicator:  
RS-232C/RS-485 communications, a linear output, or DeviceNet communications.

### Accessories (Sold Separately)

K32-DICN: Special Cable (for event inputs, with 8-pin connector)

K32-BCD: Special BCD Output Cable

#### Base Units with Optional Boards

K3HB-S       
1 2 3 4 5

#### 2. Sensor Power Supply/Output Type Codes

None: None

CPA: Relay output (PASS: SPDT) + Sensor power supply  
(12 VDC +/-10%, 80 mA) (See note 1.)

L1A: Linear current output (DC0(4) – 20 mA) + Sensor power supply  
(12 VDC +/-10%, 80 mA) (See note 2.)

L2A: Linear voltage output (DC0(1) – 5 V, 0 to 10 V) + Sensor power supply  
(12 VDC +/-10%, 80 mA) (See note 2.)

A: Sensor power supply (12 VDC +/-10%, 80 mA)

FLK1A: Communications (RS-232C) + Sensor power supply  
(12 VDC +/-10%, 80 mA) (See note 2.)

FLK3A: Communications (RS-485) + Sensor power supply  
(12 VDC +/-10%, 80 mA) (See note 2.)

#### 3. Relay/Transistor Output Type Codes

None: None

C1: Relay contact (H/L: SPDT each)

C2: Relay contact (HH/H/LL/L: SPST-NO each)

T1: Transistor (NPN open collector: HH/H/PASS/L/LL)

T2: Transistor (PNP open collector: HH/H/PASS/L/LL)

BCD: BCD output + transistor output (NPN open collector: HH/H/PASS/L/LL)

DRT: DeviceNet (See note 2.)

#### 4. Event input Type Codes

None: None

1: 5 points (M3 terminal blocks) NPN open collector

2: 8 points (10-pin MIL connector) NPN open collector

3: 5 points (M3 terminal blocks) PNP open collector

4: 8 points (10-pin MIL connector) PNP open collector



# Specifications

## ■ Ratings

<b>Power supply voltage</b>		100 to 240 VAC (50/60 Hz), 24 VAC/VDC, DeviceNet power supply: 24 VDC
<b>Allowable power supply voltage range</b>		85% to 110% of the rated power supply voltage, DeviceNet power supply: 11 to 25 VDC
<b>Power consumption (See note 1.)</b>		100 to 240 V: 18 VA max. (max. load) 24 VAC/DC: 11 VA/7 W max. (max. load)
<b>Current consumption</b>		DeviceNet power supply: 50 mA max. (24 VDC)
<b>Input</b>		DC voltage/current
<b>A/D conversion method</b>		Sequential comparison system
<b>External power supply</b>		See Sensor Power Supply/Output Type Codes
<b>Event inputs (See note 2.)</b>	<b>Timing input</b>	NPN open collector or no-voltage contact signal ON residual voltage: 3 V max. ON current at 0 Ω: 17 mA max. Max. applied voltage: 30 VDC max. OFF leakage current: 1.5 mA max.
	<b>Startup compensation timer input</b>	NPN open collector or no-voltage contact signal ON residual voltage: 2 V max. ON current at 0 Ω: 4 mA max. Max. applied voltage: 30 VDC max. OFF leakage current: 0.1 mA max.
	<b>Hold input</b>	
	<b>Reset input</b>	
	<b>Forced-zero input</b>	
	<b>Bank input</b>	
<b>Output ratings (depends on the model)</b>	<b>Relay output</b>	250 VAC, 30 VDC, 5 A (resistive load) Mechanical life expectancy: 5,000,000 operations, Electrical life expectancy: 100,000 operations
	<b>Transistor output</b>	Maximum load voltage: 24 VDC, Maximum load current: 50 mA, Leakage current: 100 μA max.
	<b>Linear output</b>	Linear output 0 to 20 mA DC, 4 to 20 mA: Load: 500 Ω max, Resolution: Approx. 10,000, Output error: ±0.5% FS Linear output 0 to 5 VDC, 1 to 5 VDC, 0 to 10 VDC: Load: 5 kΩ max, Resolution: Approx. 10,000, Output error: ±0.5% FS (1 V or less: ±0.15 V; not output for 0 V or less)
<b>Display method</b>		Negative LCD (backlit LED) display 7-segment digital display (Character height: PV: 14.2 mm (green/red); SV: 4.9 mm (green))
<b>Main functions</b>		Scaling function, 2-input calculation function, measurement operation selection, averaging, previous average value comparison, forced-zero, zero-limit, output hysteresis, output OFF delay, output test, teaching, display value selection, display color selection, key protection, bank selection, display refresh period, maximum/minimum hold, reset
<b>Ambient operating temperature</b>		-10 to 55°C (with no icing or condensation)
<b>Ambient operating humidity</b>		25% to 85%
<b>Storage temperature</b>		-25 to 65°C (with no icing or condensation)
<b>Altitude</b>		2,000 m max.
<b>Accessories</b>		Watertight packing, 2 fixtures, terminal cover, unit stickers, instruction manual. DeviceNet models also include a DeviceNet connector (Hirose HR31-5.08P-5SC(01)) and crimp terminals (Hirose HR31-SC-121) (See note 3.)

- Note:**
1. DC power supply models require a control power supply capacity of approximately 1 A per Unit when power is turned ON. Particular attention is required when using two or more DC power supply models. The OMRON S8VS-series DC Power Supply Unit is recommended.
  2. PNP input types are also available.
  3. For K3HB-series DeviceNet models, use only the DeviceNet Connector included with the product. The crimp terminals provided are for Thin Cables.

## ■ Characteristics

<b>Display range</b>		-19,999 to 99,999
<b>Sampling period</b>		One input: 0.5 ms; Two inputs: 1.0 ms
<b>Comparative output response times (transistor outputs)</b>	<b>One input</b>	OFF to ON: 1 ms max., ON to OFF: 1.5 ms max.
	<b>Two inputs</b>	OFF to ON: 2 ms max., ON to OFF: 2.5 ms max.
<b>Linear output response time</b>	<b>One input</b>	51 ms max.
	<b>Two inputs</b>	52 ms max.
<b>Insulation resistance</b>		20 MΩ min. (at 500 VDC)
<b>Dielectric strength</b>		2,300 VAC for 1 min between external terminals and case
<b>Noise immunity</b>		100 to 240 VAC models: ±1,500 V at power supply terminals in normal or common mode (waveform with 1-ns rising edge and pulse width of 1 μs/100 ns) 24 VAC/VDC models: ±1,500 V at power supply terminals in normal or common mode (waveform with 1-ns rising edge and pulse width of 1 μs/100 ns)
<b>Vibration resistance</b>		Frequency: 10 to 55 Hz; Acceleration: 50 m/s <sup>2</sup> , 10 sweeps of 5 min each in X, Y, and Z directions
<b>Shock resistance</b>		150 m/s <sup>2</sup> (100 m/s <sup>2</sup> for relay outputs) 3 times each in 3 axes, 6 directions
<b>Weight</b>		Approx. 300 g (Base Unit only)
<b>Degree of protection</b>	<b>Front panel</b>	Conforms to NEMA 4X for indoor use (equivalent to IP66)
	<b>Rear case</b>	IP20
	<b>Terminals</b>	IP00 + finger protection (VDE0106/100)
<b>Memory protection</b>		EEPROM (non-volatile memory) Number of rewrites: 100,000
<b>Applicable standards</b>		UL61010C-1, CSA C22.2 No. 1010.1 (evaluated by UL) EN61010-1 (IEC61010-1): Pollution degree 2/Overvoltage category II EN61326: 1997, A1: 1998, A2: 2001
<b>EMC</b>		EMI: EN61326+A1 industrial applications Electromagnetic radiation interference CISPR 11 Group 1, Class A: CISPRL16-1/-2 Terminal interference voltage CISPR 11 Group 1, Class A: CISPRL16-1/-2 EMS: EN61326+A1 industrial applications Electrostatic Discharge Immunity EN61000-4-2: 4 kV (contact), 8 kV (in air) Radiated Electromagnetic Field Immunity EN61000-4-3: 10 V/m 1 kHz sine wave amplitude modulation (80 MHz to 1 GHz) Electrical Fast Transient/Burst Immunity EN61000-4-4: 2 kV (power line), 1 kV (I/O signal line) Surge Immunity EN61000-4-5: 1 kV with line (power line), 2 kV with ground (power line) Conducted Disturbance Immunity EN61000-4-6: 3 V (0.15 to 80 MHz) Voltage Dips and Interruptions Immunity EN61000-4-11: 0.5 cycle, 0°/180°, 100% (rated voltage)

## ■ Input Ranges (Measurement Ranges and Accuracy)

Input	Input type	Measurement range	Indication range	Input impedance	Accuracy (at 23±5°C)	Maximum absolute rated input
K3HB-SSD DC voltage/current input	0 to 20 mA	0.000 to 20.000 mA	-2.000 to 22.000 mA	120 Ω max.	One input: ±0.1% F.S. ±1 digit max.	±31 mA
	4 to 20 mA	4.000 to 20.000 mA	2.000 to 22.000 mA			
	0 to 5 V	0.000 to 5.000 V	-0.500 to 5.500 mA	1 MΩ min.	Two inputs: ±0.2% F.S. ±1 digit max.	±10 V
	1 to 5 V	1.000 to 5.000 V	0.500 to 5.500 V			
	±5 V	±5.000 V	± 5.500 V			
	±10 V	±10.000 V	± 11.000 V			

**Note:** The accuracy is for an ambient temperature of 23±5°C.

Input type		DC current input		Input type		DC voltage input			
Connected terminals		0-20	4-20	Connected terminals		0-5	1-5	5	10
Input A	0-2A	(E2) - (E3)		Input A	0-2A	(E4) - (E3)			
Input B	0-2b	(E1) - (E3)		Input B	0-2b	(E5) - (E3)			
DC current range (mA)	24.000	22.000	22.000	DC voltage range (V)					
	20.000								
	16.000				5.500	5.500	5.500	11.000	
	12.000				-0.500	0.500	5.500		
	8.000						-5.500		
	4.000								
0.000									
-4.000									

The range shown in dark shading indicates the factory setting.

## Sampling and Comparative Output Response Times

The K3HB-S sampling and comparative output response times depend on the calculation methods, timing hold type, and, for simple averaging, the averaging times. Refer to the following description for details.

### Output Refresh Period

The K3HB-S repeats input reads, calculation, and judgement output processing. The output refresh period differs depending on whether there are one or two inputs, as outlined below.

#### One Input

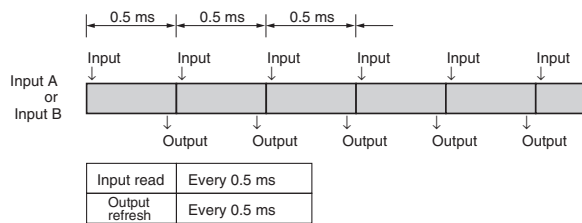

#### Two inputs

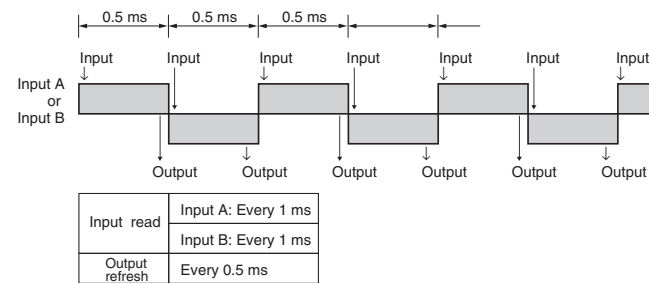

### Output Response Time

The comparative output response time is the sum of the data processing time and the output (relay or transistor) response time.

#### One Input

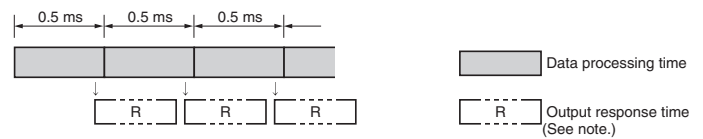

#### Two Inputs

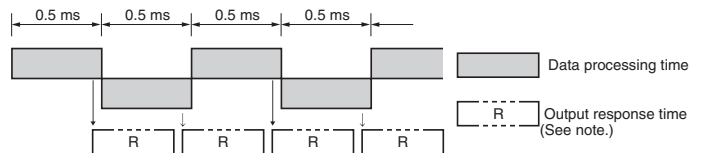

**Note:** For transistor outputs:

For one input: OFF to ON 1 ms and ON to OFF 1.5 ms  
For two inputs: OFF to ON 2 ms and ON to OFF 2.5 ms

For relay outputs:

The relay operation time of 15 ms is added to the transistor output response times.

# Common Specifications

## ■ Event Input Ratings

Input type	S-TMR, HOLD, RESET, ZERO, BANK1, BANK2, BANK4	TIMING
Contact	ON: 1 kΩ max., OFF: 100 kΩ min.	---
No-contact	ON residual voltage: 2 V max. OFF leakage current: 0.1 mA max. Load current: 4 mA max. Maximum applied voltage: 30 VDC max.	ON residual voltage: 3 V max. OFF leakage current: 1.5 mA max. Load current: 17 mA max. Maximum applied voltage: 30 VDC max.

## ■ Output Ratings

### Contact Output

Item	Resistive loads (250 VAC, cosφ=1; 30 VDC, L/R=0 ms)	Inductive loads (250 VAC, closed circuit, cosφ=0.4; 30 VDC, L/R=7 ms)
Rated load	5 A at 250 VAC 5 A at 30 VDC	1 A at 250 VAC 1 A at 30 VDC
Rated through current	5A	
Mechanical life expectancy	5,000,000 operations	
Electrical life expectancy	100,000 operations	

### Transistor Output

Maximum load voltage	24 VDC
Maximum load current	50 mA
Leakage current	100 μA max.

### Linear Output

Item	0 to 20 mA	4 to 20 mA	0 to 5 V	1 to 5 V	0 to 10 V
Allowable load impedance	500 Ω max.		5 kΩ min.		
Resolution	Approx. 10,000				
Output error	±0.5%FS				

### Serial Communications Output

Item	RS-232C, RS-485
Communications method	Half duplex
Synchronization method	Start-stop synchronization
Baud rate	9,600, 19,200, or 38,400 bps
Transmission code	ASCII
Data length	7 bits or 8 bits
Stop bit length	2 bits or 1 bit
Error detection	Vertical parity and FCS
Parity check	Odd, even

**Note:** For details on serial and DeviceNet communications, refer to the *Digital Indicator K3HB Communications User's Manual* (Cat.No. N129).

### BCD Output I/O Ratings

#### (Input Signal Logic: Negative)

I/O signal name		Item	Rating	
Inputs	REQUEST	Input signal	No-voltage contact input	
	HOLD	Input current for no-voltage input	10 mA	
	MAX	Signal level	ON voltage	1.5 V max.
	MIN		OFF voltage	3 V min.
RESET				
Outputs	DATA	Maximum load voltage	24 VDC	
	POLARITY	Maximum load current	10 mA	
	OVER	Leakage current	100 μA max.	
	DATA VALID			
	RUN			
	HH	Maximum load voltage	24 VDC	
	H	Maximum load current	50 mA	
	PASS	Leakage current	100 μA max.	
	L			
LL				

**Note:** For details on serial and DeviceNet communications, refer to the *Digital Indicator K3HB Communications User's Manual* (Cat.No. N129).

## DeviceNet Communications

<b>Communications protocol</b>		Conforms to DeviceNet																
<b>Supported communications</b>	<b>Remote I/O communications</b>	Master-Slave connection (polling, bit-strobe, COS, cyclic) Conforms to DeviceNet communications standards.																
	<b>I/O allocations</b>	Allocate any I/O data using the Configurator. Allocate any data, such as DeviceNet-specific parameters and variable area for Digital Indicators. Input area: 2 blocks, 60 words max. Output area: 1 block, 29 words max. (The first word in the area is always allocated for the Output Execution Enabled Flags.)																
	<b>Message communications</b>	Explicit message communications CompoWay/F communications commands can be executed (using explicit message communications)																
<b>Connection methods</b>		Combination of multi-drop and T-branch connections (for trunk and drop lines)																
<b>Baud rate</b>		DeviceNet: 500, 250, or 125 Kbps (automatic follow-up)																
<b>Communications media</b>		Special 5-wire cable (2 signal lines, 2 power supply lines, 1 shield line)																
<b>Communications distance</b>		<table border="1"> <thead> <tr> <th>Baud rate</th> <th>Network length (max.)</th> <th>Drop line length (max.)</th> <th>Total drop line length (max.)</th> </tr> </thead> <tbody> <tr> <td>500 Kbps</td> <td>100 m (100 m)</td> <td>6 m</td> <td>39 m</td> </tr> <tr> <td>250 Kbps</td> <td>100 m (250 m)</td> <td>6 m</td> <td>78 m</td> </tr> <tr> <td>125 Kbps</td> <td>100 m (500 m)</td> <td>6 m</td> <td>156 m</td> </tr> </tbody> </table> <p>The values in parentheses are for Thick Cable.</p>	Baud rate	Network length (max.)	Drop line length (max.)	Total drop line length (max.)	500 Kbps	100 m (100 m)	6 m	39 m	250 Kbps	100 m (250 m)	6 m	78 m	125 Kbps	100 m (500 m)	6 m	156 m
Baud rate	Network length (max.)	Drop line length (max.)	Total drop line length (max.)															
500 Kbps	100 m (100 m)	6 m	39 m															
250 Kbps	100 m (250 m)	6 m	78 m															
125 Kbps	100 m (500 m)	6 m	156 m															
<b>Communications power supply</b>		24-VDC DeviceNet power supply																
<b>Allowable voltage fluctuation range</b>		11 to 25-VDC DeviceNet power supply																
<b>Current consumption</b>		50 mA max. (24 VDC)																
<b>Maximum number of nodes</b>		64 (DeviceNet Configurator is counted as one node when connected)																
<b>Maximum number of slaves</b>		63																
<b>Error control checks</b>		CRC errors																
<b>DeviceNet power supply</b>		Supplied from DeviceNet communications connector																

## Internal Block Diagram

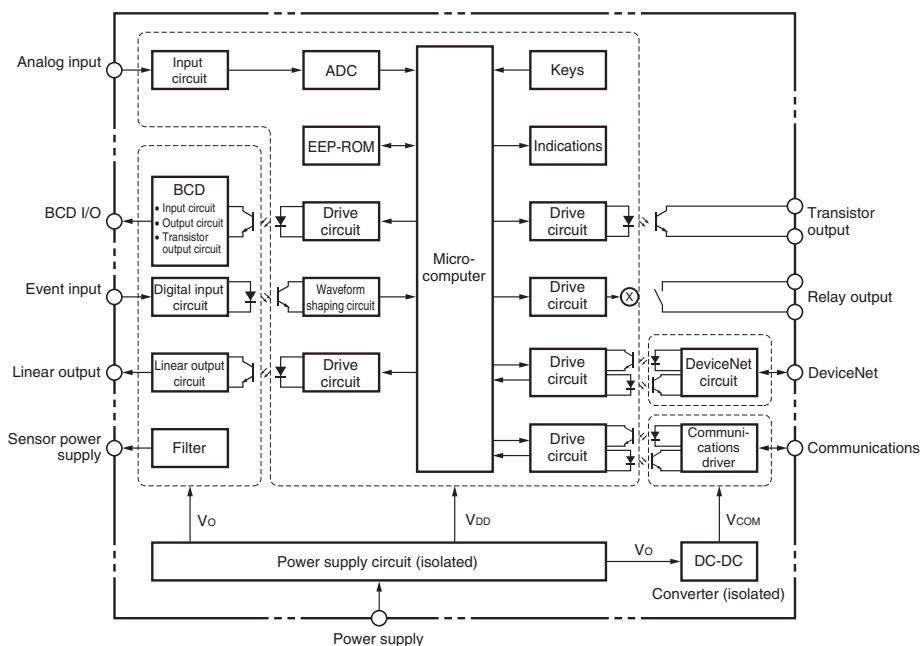

## Power Supply Derating Curve for Sensor (Reference Value)

With 12 V

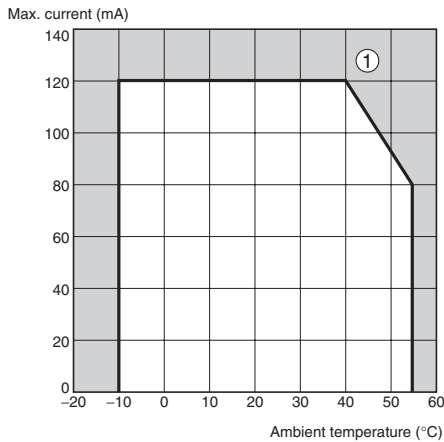

With 10 V

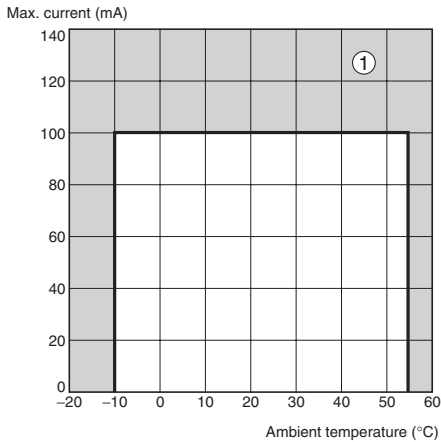

- Note:**
- The above values are for standard mounting. The derating curve differs depending on the mounting conditions.
  - Do not use the Sensor outside of the derating area (i.e., do not use it in the area labeled ① in the above graphics). Doing so may occasionally cause deterioration or damage to internal components.

## Component Names and Functions

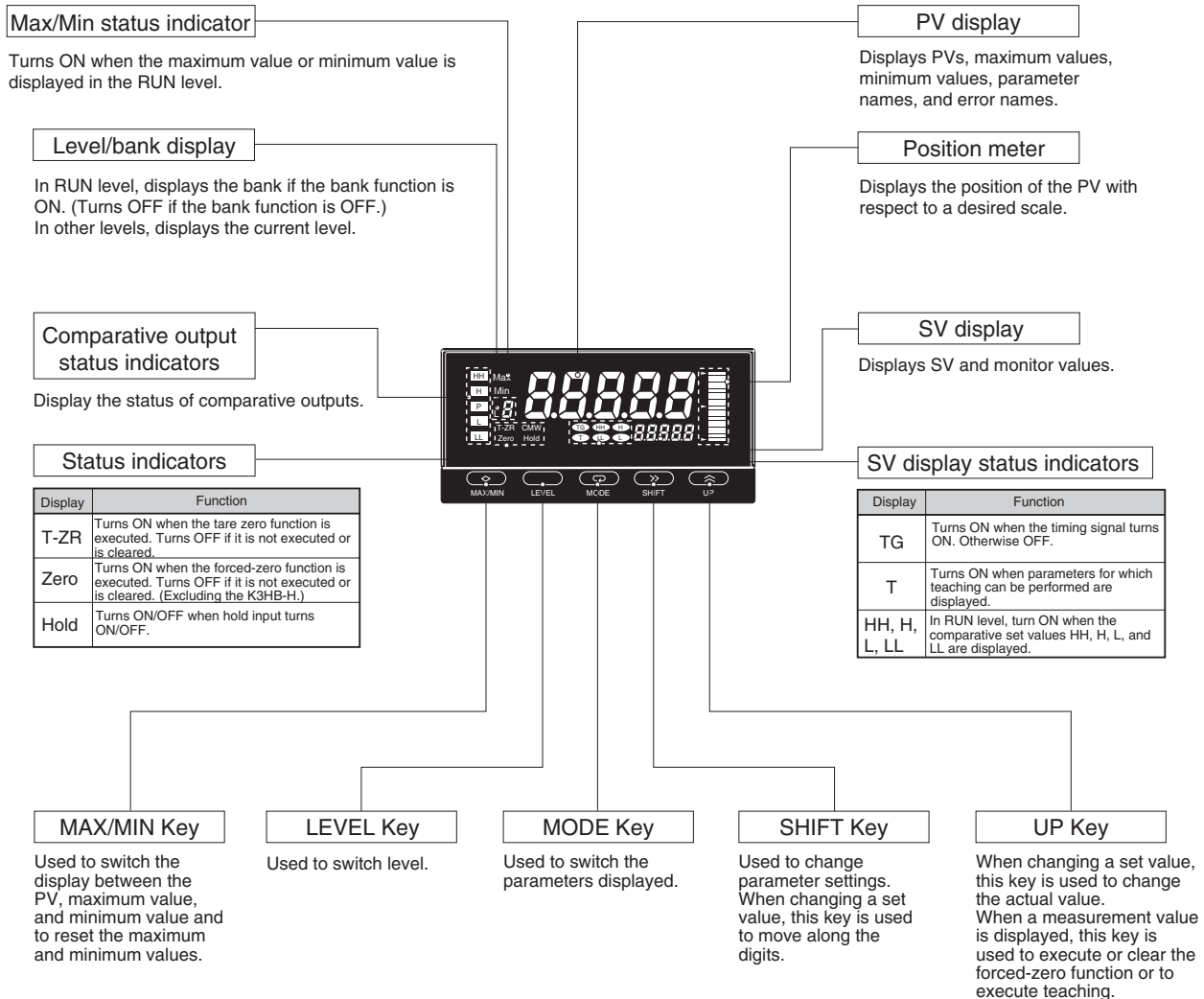

# BCD Output Timing Chart

A REQUEST signal from a Programmable Controller or other external device is required to read BCD data.

## Single Sampling Data Output

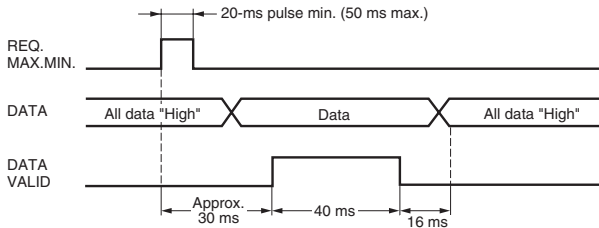

The data is set in approximately 30 ms from the rising edge of the REQUEST signal and the DATA VALID signal is output. When reading the data from a Programmable Controller, start reading the data when the DATA VALID signal turns ON. The DATA VALID signal will turn OFF 40 ms later, and the data will turn OFF 16 ms after that.

## Continuous Data Output

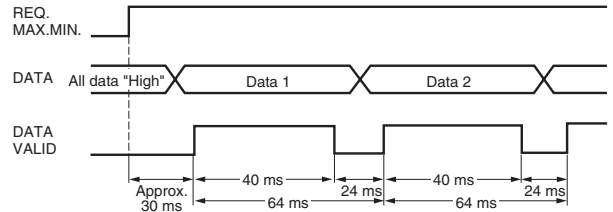

Measurement data is output every 64 ms while the REQUEST signal remains ON.

**Note:** If HOLD is executed when switching between data 1 and data 2, either data 1 or data 2 is output depending on the timing of the hold signal. The data will not go LOW.

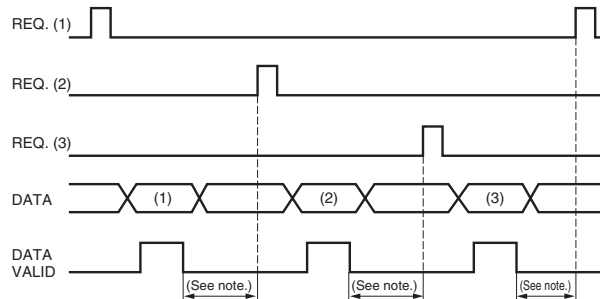
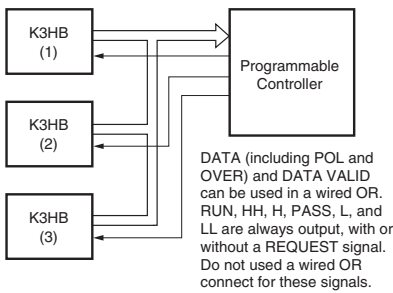

**Note:** Leave 20 ms min. between DATA VALID turning OFF and the REQUEST signal.

## Programmable Controller Connection Example

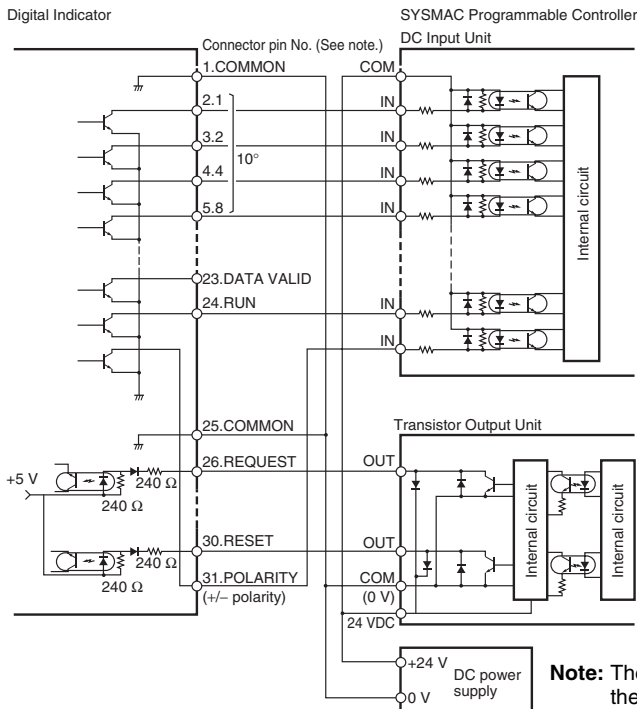

## Display Unit Connection Example

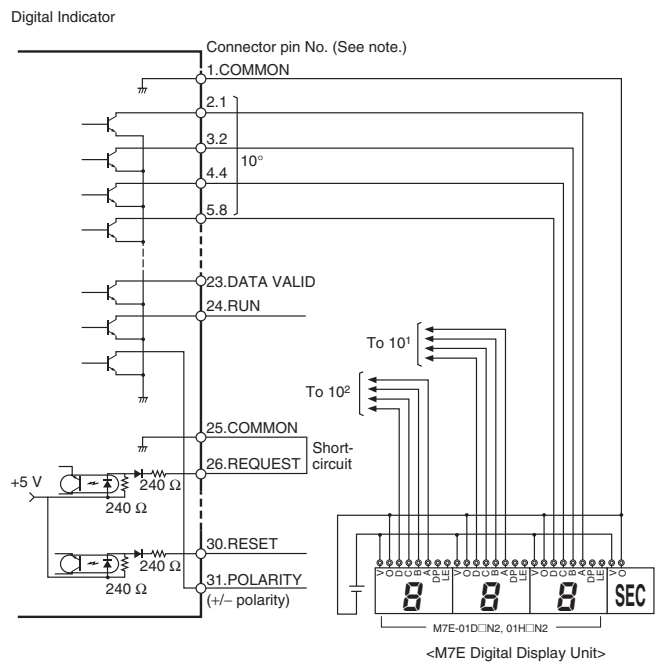

**Note:** The BCD output connector pin number is the D-sub connector pin number when the BCD Output Cable (sold separately) is connected. This number differs from the pin number for the Digital Indicator narrow pitch connector (manufactured by Honda Tsushin Kogyo Co., Ltd.).

Refer to the following User's Manual for application precautions and other information required when using the Digital Indicator:  
 K3HB-S/-X/-V/-H Digital Indicator User's Manual (Cat. No. N128)  
 The manual can be downloaded from the following site in PDF format: OMRON Industrial Web <http://www.fa.omron.co.jp>

# Connections

## Terminal Arrangement

**Note:** Insulation is used between signal input, event input, output, and power supply terminals.

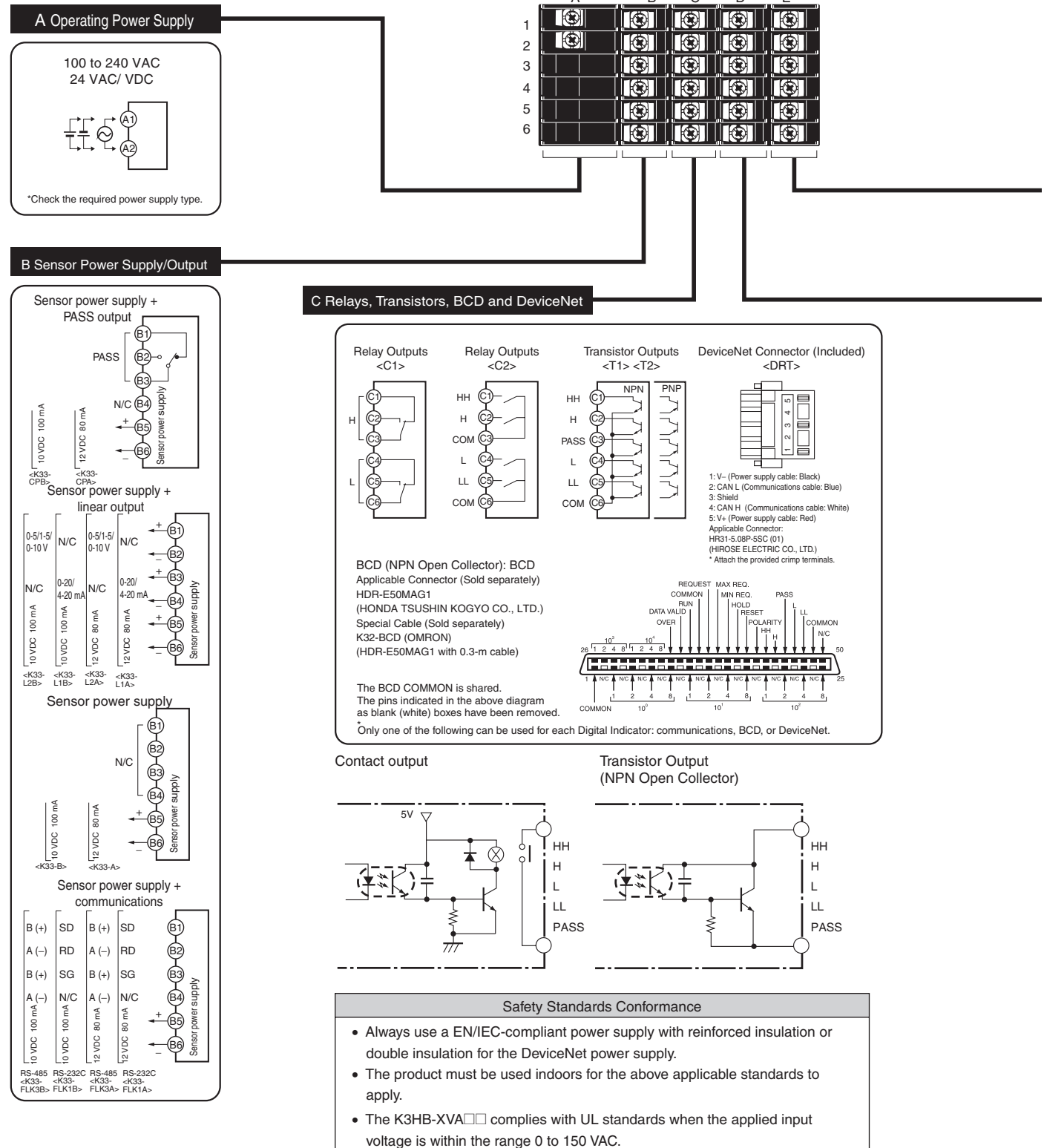



**E Analog Input**

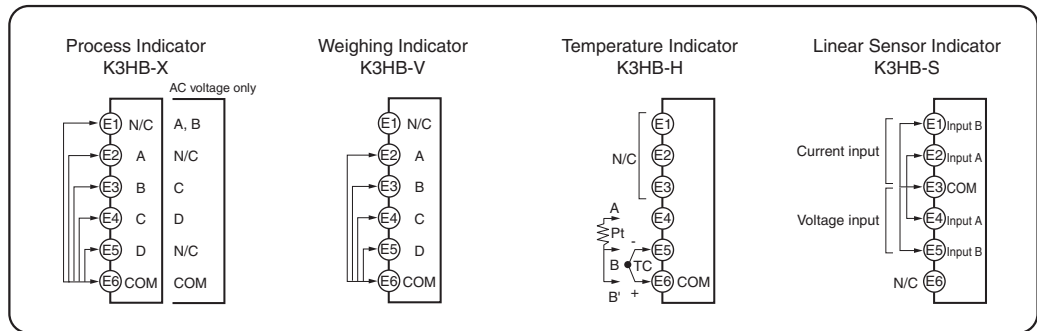

**D Event Input**

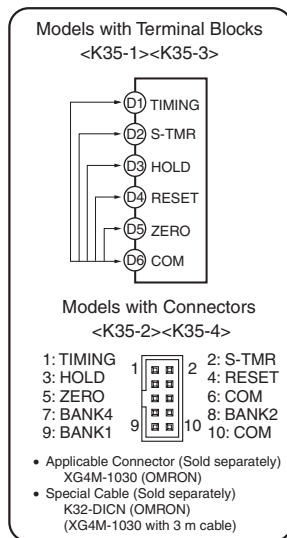

- Use terminal pin D6 as the common terminal.
- Use NPN open collector or no-voltage contacts for event input. PNP types are also available.

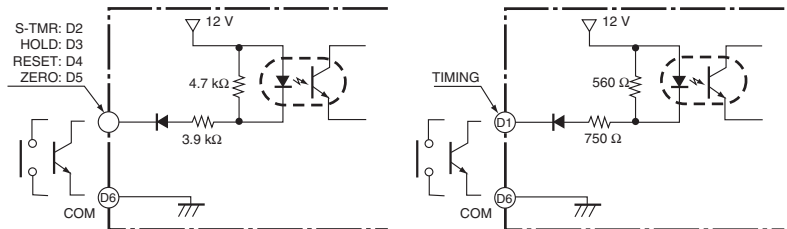

**BCD Output Cable**

Model	Shape	Pin arrangement
K32-BCD	<p>Cover: HDR-E50LPA5 (manufactured by Honda Tsushin Co., Ltd) Connector: HDR-E50MAG1 (manufactured by Honda Tsushin Co., Ltd)</p> <p>D-sub connector (37-pin female) Cover: 17JE-37H-1A (manufactured by DDK) Connector: Equivalent to 17JE-13370-02 (manufactured by DDK) Stand: 17L-002A (manufactured by DDK)</p>	<p>COMMON → 1 10<sup>0</sup> → 2, 3, 4, 8 10<sup>1</sup> → 1, 2, 4, 8 10<sup>2</sup> → 1, 2, 4, 8 10<sup>3</sup> → 1, 2, 4, 8 10<sup>4</sup> → 1, 2</p> <p>Labels: OVER, DATA VALID, RUN, COMMON, REQUEST, MAX REQ., MIN REQ., HOLD, RESET, POLARITY, HH, H, PASS, L, LL, COMMON</p>

**Note:** The BCD Output Cable has a D-sub plug. Cover: 17JE-37H-1A (manufactured by DDK); Connector: equivalent to 17JE-23370-02 (D1) (manufactured by DDK)

**Special Cable (for Event Inputs with 8-pin Connector)**

Model	Appearance	Wiring																						
K32-DICN		<table border="1"> <thead> <tr> <th>Pin No.</th> <th>Signal name</th> </tr> </thead> <tbody> <tr><td>1</td><td>N/C</td></tr> <tr><td>2</td><td>S-TMR</td></tr> <tr><td>3</td><td>HOLD</td></tr> <tr><td>4</td><td>RESET</td></tr> <tr><td>5</td><td>N/C</td></tr> <tr><td>6</td><td>COM</td></tr> <tr><td>7</td><td>BANK4</td></tr> <tr><td>8</td><td>BANK2</td></tr> <tr><td>9</td><td>BANK1</td></tr> <tr><td>10</td><td>COM</td></tr> </tbody> </table>	Pin No.	Signal name	1	N/C	2	S-TMR	3	HOLD	4	RESET	5	N/C	6	COM	7	BANK4	8	BANK2	9	BANK1	10	COM
Pin No.	Signal name																							
1	N/C																							
2	S-TMR																							
3	HOLD																							
4	RESET																							
5	N/C																							
6	COM																							
7	BANK4																							
8	BANK2																							
9	BANK1																							
10	COM																							

# Main Functions

## Measurement

### Input Calculation **S**

- Two input circuits are provided. The input ranges for these circuits can be set independently. For example, one can be set to 4 to 20 mA and the other can be set to 1 to 5 V.
- In addition to calculations such as K (constant)–A (input for one circuit), it is possible to perform calculations based on the inputs for both circuits, such as A+B and A–B, making it possible to perform thickness measurement and level-difference measurement using displacement and length-measuring sensors.

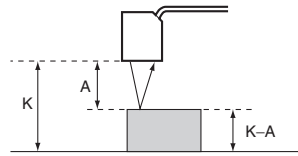

### Timing Hold **X V H S**

#### Normal

- Continuously performs measurement and always outputs based on comparative results.

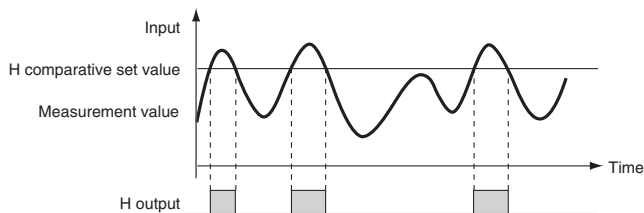

#### Sampling Hold

- Holds the measurement at the rising edge of the TIMING signal.

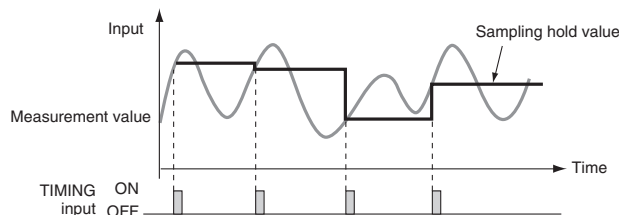

#### Peak Hold/Bottom Hold

- Measures the maximum (or minimum) value in a specified period.

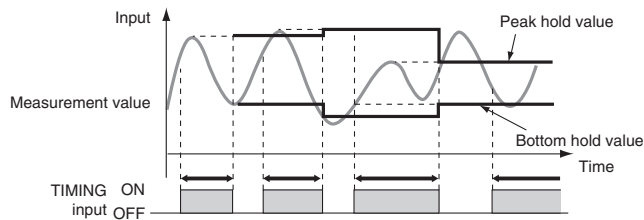

#### Peak-to-peak Hold

- Measures the difference between the maximum and minimum values in a specified period.

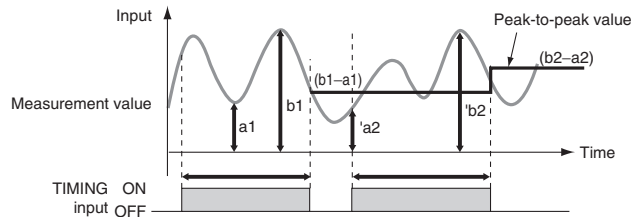

### Scaling **X V S**

Scaling converts input signals in any way required before displaying them. The values can be manipulated by shifting, inverting, or +/- reversing.

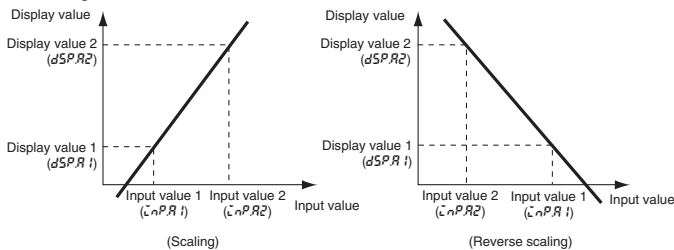

### Average Processing **X V H S**

Turns the comparative output OFF until the measurement value enters the PASS range.

Average processing of input signals with extreme changes or noise smooths out the display and makes control stable.

### Previous Average Value Comparison **X V H S**

Slight changes can be removed from input signals to detect only extreme changes.

### Temperature Input Shift **H**

Shifts the temperature input value.

### Teaching **X V S**

Settings for scaling can be made using the present measurement values instead of inputting values with the SHIFT and UP Keys. This is a convenient function for making the settings while monitoring the operating status.

### Standby Sequence **X V H S**

#### Supported Models

The models that support the functions shown here are indicated by symbols as follows:

- X** K3HB-X
- V** K3HB-V
- H** K3HB-H
- S** K3HB-S

## Input Compensation/Display

### Forced-zero

X V S

Forces the present value to 0. (Convenient for setting reference values or deducting tares for weight measurement.)

### Tare Zero

V S

Shifts the current value measured with a forced zero to 0 again. It is possible to measure two or more compounds separately and then, by releasing the tare zero and forced-zero, measure the combined total.

### Zero-trimming

X V H S

Compensates for mild fluctuations in input signals due to factors such as sensor temperature drift, based on OK (PASS) data at measurement. (This function can be used with sampling hold, peak hold, or bottom hold.)

### Zero-limit

X V H S

Changes the display value to 0 for input values less than the set value. It is enabled in normal mode only. (This function can be used, for example, to stop negative values being displayed or to eliminate flickering and minor inconsistencies near 0.)

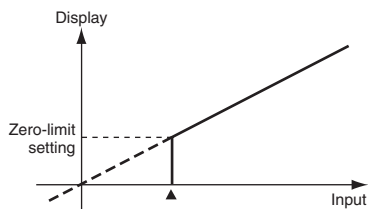

### Display Refresh Period

X V H S

The display refresh period can be lengthened to reduce flickering and thereby make the display easier to read.

### Display Color Selection

X V H S

Values can be displayed in either red or green. With comparative output models, the display color can also be set to change according to the status of comparative outputs (e.g., green to red or red to green).

Example) Setting: Green

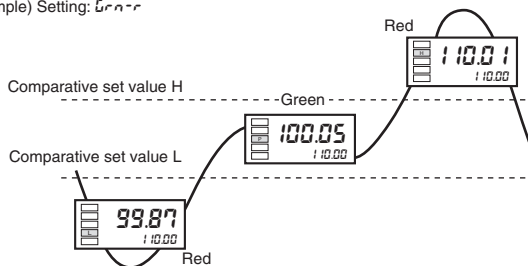

### Display Value Selection

X V H S

The current display value can be selected from the present value, the maximum value, and the minimum value.

### Step Value

X V H S

It is possible to specify (i.e., restrict) the values that the smallest displayed digit can change by. For example, if the setting is 2, the smallest digit will only take the values 0, 2, 4, 6, or 8 and if the setting is 5, it will only take the values 0 or 5. If the setting is 10, it will only take the value of 0.

## Output

### Comparative Output Pattern

X V H S

The output pattern for comparative outputs can be selected. In addition to high/low comparison with set values, output based on level changes is also possible. (Use the type of output pattern appropriate for the application.)

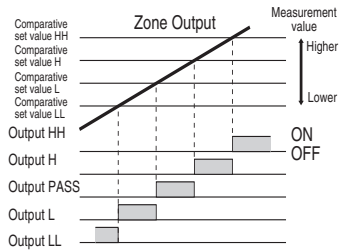
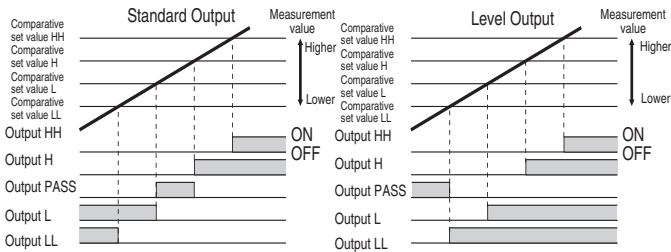

### Output Logic

X V H S

Reverses the output operation of comparative outputs for comparative results.

### Hysteresis

X V H S

Prevents comparative output chattering when the measurement value fluctuates slightly near the set value.

Example: Comparative Output Pattern (Standard Output)

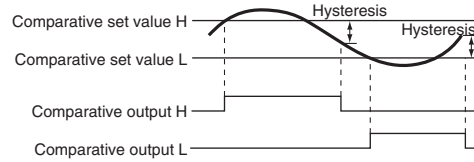

### Startup Compensation Timer

X V H S

Measurement can be stopped for a set time using external input.

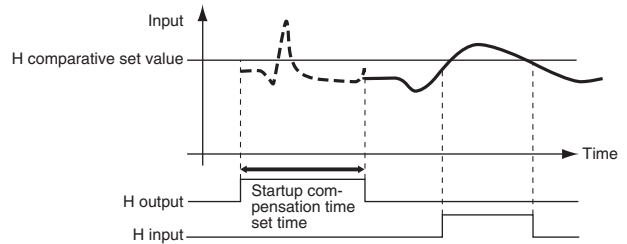

### PASS Output Change

X V H S

Comparative results other than PASS and error signals can be output from the PASS output terminal.

## Dimensions

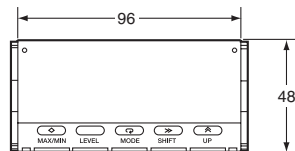
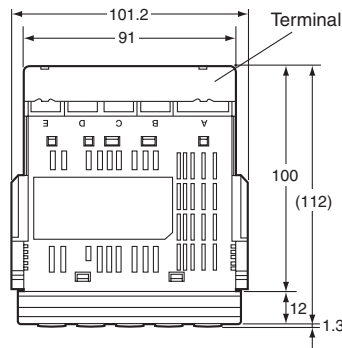
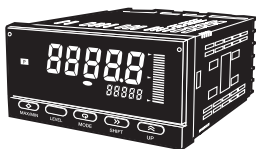

Terminal cover (included)

Character Size for Main Display (mm)

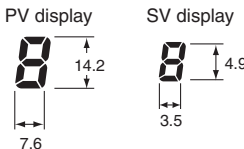

Panel Cutout Dimensions

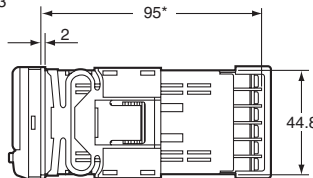
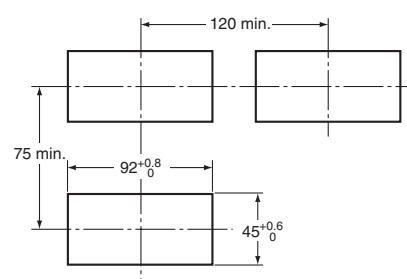

\*DeviceNet models: 97 mm  
Terminal: M3, Terminal Cover: Accessory

## ■ Wiring Precautions

- For terminal blocks, use the crimp terminals suitable for M3 screws.
- Tighten the terminal screws to the recommended tightening torque of approx. 0.5 N·m.
- To prevent inductive noise, separate the wiring for signal lines from that for power lines.

## Wiring

- Use the crimp terminals suitable for M3 screws shown below.

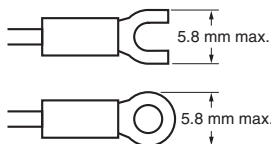

## Unit Stickers

- Select the appropriate units from the unit sticker sheets provided and attach the sticker to the Indicator.

V	A	V	A	%	J	Pa	Ω
s	/	N	m	W	°C	m <sup>3</sup>	k
°F	g	min	mm	rpm			
VA	mV	mA	Hz				
m/min	OMRON						
OUT	OUT						

**Note:** When using for meters, such as weighing meters, use the units specified by regulations on weights and measures.

## ■ Mounting Method

1. Insert the K3HB into the mounting cutout in the panel.
2. Insert watertight packing around the Unit to make the mounting watertight.

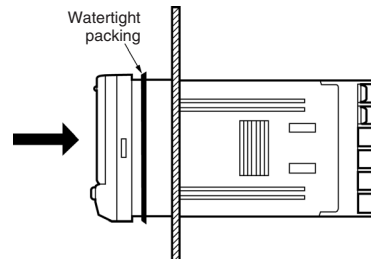

3. Insert the adapter into the grooves on the left and right sides of the rear case and push until it reaches the panel and is fixed in place.

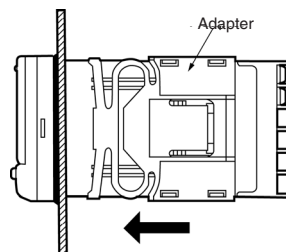

## ■ LCD Field of Vision

The K3HB is designed to have the best visibility at the angles shown in the following diagram.

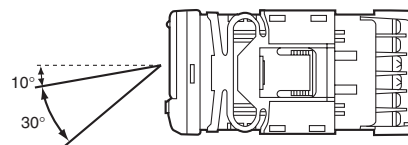

## ■ Waterproof Packing

The waterproof packing ensures a level of waterproofing that conforms to NEMA 4X. Depending on the operating environment, deterioration, contraction, or hardening may occur and replacement may be necessary. In this case, consult your OMRON representative.

## ■ Precautions

### WARNING

Do not touch the terminals while power is being supplied. Doing so may possibly result in electric shock. Make sure that the terminal cover is installed before using the product.



Always provide protective circuits in the network. Without protective circuits, malfunctions may possibly result in accidents that cause serious injury or significant property damage.

Provide double or triple safety measures in external control circuits, such as emergency stop circuits, interlock circuits, or limit circuits, to ensure safety in the system if an abnormality occurs due to malfunction of the product or another external factor affecting the product's operation.



### CAUTION

Do not allow pieces of metal, wire clippings, or fine metallic shavings or filings from installation to enter the product. Doing so may occasionally result in minor electric shock, fire, or malfunction.



Do not use the product in locations where flammable or explosive gases are present. Doing so may occasionally result in explosion, causing minor or moderate injury, or property damage.



Do not attempt to disassemble, repair, or modify the product. Doing so may occasionally result in minor or moderate injury due to electric shock.



Do not use the equipment for measurements within Measurement Categories III and IV for K3HB-X and II, III, and IV for K3HB-S, K3HB-V, and K3HB-H (according to IEC61010-1). Doing so may occasionally cause unexpected operation, resulting in minor or moderate injury, or damage to the equipment. Use the equipment for measurements only within the Measurement Category for which the product is designed.



Perform correct setting of the product according to the application. Failure to do so may occasionally cause unexpected operation, resulting in minor or moderate injury, or damage to the equipment.



Ensure safety in the event of product failure by taking safety measures, such as installing a separate monitoring system. Product failure may occasionally prevent operation of comparative outputs, resulting in damage to the connected facilities and equipment.



Tighten the screws on the terminal block and the connector locking screws securely using a tightening torque within the following ranges. Loose screws may occasionally cause fire, resulting in minor or moderate injury, or damage to the equipment.



Terminal block screws: 0.43 to 0.58 N·m

Connector locking screws: 0.18 to 0.22 N·m

Make sure that the product will not be adversely affected if the DeviceNet cycle time is lengthened as a result of changing the program with online editing. Extending the cycle time may cause unexpected operation, occasionally resulting in minor or moderate injury, or damage to the equipment.



Before transferring programs to other nodes or changing I/O memory of other nodes, check the nodes to confirm safety. Changing the program or I/O memory of other nodes may occasionally cause unexpected operation, resulting in minor or moderate injury, or damage to the equipment.



## Precautions for Safe Use

- Do not use the product in the following locations.
  - Locations subject to direct radiant heat from heating equipment
  - Locations where the product may come into contact with water or oil
  - Locations subject to direct sunlight
  - Locations where dust or corrosive gases (in particular, sulfuric or ammonia gas) are present
  - Locations subject to extreme temperature changes
  - Locations where icing or condensation may occur
  - Locations subject to excessive shocks or vibration
- Do not use the product in locations subject to temperatures or humidity levels outside the specified ranges or in locations prone to condensation. If the product is installed in a panel, ensure that the temperature around the product (not the temperature around the panel) does not go outside the specified range.
- Provide sufficient space around the product for heat dissipation.
- Use and store the product within the specified temperature and humidity ranges. If several products are mounted side-by-side or arranged in a vertical line, the heat dissipation will cause the internal temperature of the products to rise, shortening the service life. If necessary, cool the products using a fan or other cooling method.
- The service life of the output relays depends on the switching capacity and switching conditions. Consider the actual application conditions and use the product within the rated load and electrical service life. Using the product beyond its service life may result in contact welding or burning.
- Install the product horizontally.
- Mount to a panel between 1 and 8-mm thick.
- Use the specified size of crimp terminals (M3, width: 5.8 mm max.) for wiring. To connect bare wires, use AWG22 (cross section: 0.326 mm<sup>2</sup>) to AWG14 (cross section: 2.081 mm<sup>2</sup>) to wire the power supply terminals and AWG28 (cross section: 0.081 mm<sup>2</sup>) to AWG16 (cross section: 1.309 mm<sup>2</sup>) for other terminals. (Length of exposed wire: 6 to 8 mm)
- In order to prevent inductive noise, wire the lines connected to the product separately from power lines carrying high voltages or currents. Do not wire in parallel with or in the same cable as power lines. Other measures for reducing noise include running lines along separate ducts and using shield lines.
- Ensure that the rated voltage is achieved no longer than 2 s after turning the power ON.
- Allow the product to operate without load for at least 15 minutes after the power is turned ON.
- Do not install the product near devices generating strong high-frequency waves or surges. When using a noise filter, check the voltage and current and install it as close to the product as possible.
- Do not use thinner to clean the product. Use commercially available alcohol.
- Be sure to confirm the name and polarity for each terminal before wiring the terminal block and connectors.
- Use the product within the noted supply voltage and rated load.
- Do not connect anything to unused terminals.
- Output turns OFF when the mode is changed or settings are initialized. Take this into consideration when setting up the control system.
- Install an external switch or circuit breaker that complies with applicable IEC60947-1 and IEC60947-3 requirements and label them clearly so that the operator can quickly turn OFF the power.
- Use the specified cables for the communications lines and stay within the specified DeviceNet communications distances. Refer to the User's Manual (Cat. No. N129) for details on communications distance specifications and cables.
- Do not pull the DeviceNet communications cables with excessive force or bend them past their natural bending radius.

- 21. Do not connect or remove connectors while the DeviceNet power is being supplied. Doing so will cause product failure or malfunction.
- 22. Use cables with a heat resistance of 70°C min.

## ■ Noise Countermeasures

- 1. Do not install the product near devices generating strong high-frequency waves or surges, such as high-frequency welding and sewing machines.
- 2. Mount a surge suppressor or noise filter to peripheral devices generating noise, in particular, motors, transformers, solenoids, and magnet coils.

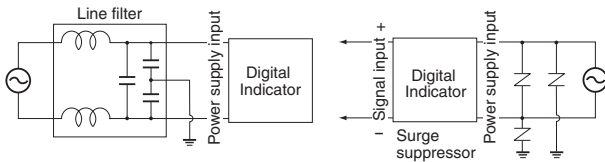

- 3. In order to prevent inductive noise, wire the lines connected to the terminal block separately from power lines carrying high voltages or currents. Do not wire in parallel with or in the same cable as power lines. Other measures for reducing noise include running lines along separate ducts and using shield lines.

### Example of Countermeasures for Inductive Noise on Input Lines

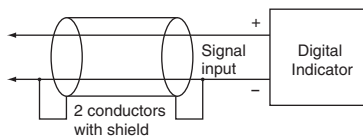

- 4. If a noise filter is used for the power supply, check the voltage and current, and install the noise filter as close to the product as possible.
- 5. Reception interference may occur if the product is used close to a radio, television, or wireless.

# Warranty and Limitations of Liability

---

## ■ WARRANTY

OMRON's exclusive warranty is that the products are free from defects in materials and workmanship for a period of one year (or other period if specified) from date of sale by OMRON.

OMRON MAKES NO WARRANTY OR REPRESENTATION, EXPRESS OR IMPLIED, REGARDING NON-INFRINGEMENT, MERCHANTABILITY, OR FITNESS FOR PARTICULAR PURPOSE OF THE PRODUCTS. ANY BUYER OR USER ACKNOWLEDGES THAT THE BUYER OR USER ALONE HAS DETERMINED THAT THE PRODUCTS WILL SUITABLY MEET THE REQUIREMENTS OF THEIR INTENDED USE. OMRON DISCLAIMS ALL OTHER WARRANTIES, EXPRESS OR IMPLIED.

## ■ LIMITATIONS OF LIABILITY

OMRON SHALL NOT BE RESPONSIBLE FOR SPECIAL, INDIRECT, OR CONSEQUENTIAL DAMAGES, LOSS OF PROFITS, OR COMMERCIAL LOSS IN ANY WAY CONNECTED WITH THE PRODUCTS, WHETHER SUCH CLAIM IS BASED ON CONTRACT, WARRANTY, NEGLIGENCE, OR STRICT LIABILITY.

In no event shall the responsibility of OMRON for any act exceed the individual price of the product on which liability is asserted.

IN NO EVENT SHALL OMRON BE RESPONSIBLE FOR WARRANTY, REPAIR, OR OTHER CLAIMS REGARDING THE PRODUCTS UNLESS OMRON'S ANALYSIS CONFIRMS THAT THE PRODUCTS WERE PROPERLY HANDLED, STORED, INSTALLED, AND MAINTAINED AND NOT SUBJECT TO CONTAMINATION, ABUSE, MISUSE, OR INAPPROPRIATE MODIFICATION OR REPAIR.

# Application Considerations

---

## ■ SUITABILITY FOR USE

OMRON shall not be responsible for conformity with any standards, codes, or regulations that apply to the combination of products in the customer's application or use of the products.

At the customer's request, OMRON will provide applicable third party certification documents identifying ratings and limitations of use that apply to the products. This information by itself is not sufficient for a complete determination of the suitability of the products in combination with the end product, machine, system, or other application or use.

The following are some examples of applications for which particular attention must be given. This is not intended to be an exhaustive list of all possible uses of the products, nor is it intended to imply that the uses listed may be suitable for the products.

- Outdoor use, uses involving potential chemical contamination or electrical interference, or conditions or uses not described in this catalog.
- Nuclear energy control systems, combustion systems, railroad systems, aviation systems, medical equipment, amusement machines, vehicles, safety equipment, and installations subject to separate industry or government regulations.
- Systems, machines, and equipment that could present a risk to life or property.

Please know and observe all prohibitions of use applicable to the products.

NEVER USE THE PRODUCTS FOR AN APPLICATION INVOLVING SERIOUS RISK TO LIFE OR PROPERTY WITHOUT ENSURING THAT THE SYSTEM AS A WHOLE HAS BEEN DESIGNED TO ADDRESS THE RISKS, AND THAT THE OMRON PRODUCTS ARE PROPERLY RATED AND INSTALLED FOR THE INTENDED USE WITHIN THE OVERALL EQUIPMENT OR SYSTEM.

**ALL DIMENSIONS SHOWN ARE IN MILLIMETERS.**

To convert millimeters into inches, multiply by 0.03937. To convert grams into ounces, multiply by 0.03527.

Cat. No. N131-E1-04 **In the interest of product improvement, specifications are subject to change without notice.**

---

## OMRON Corporation

Industrial Automation Company

### Control Devices Division H.Q.

#### Analog Controller Division

Shiokoji Horikawa, Shimogyo-ku,  
Kyoto, 600-8530 Japan

Tel: (81)75-344-7080/Fax: (81)75-344-7189

### OMRON EUROPE B.V.

Wegalaan 67-69, NL-2132 JD Hoofddorp  
The Netherlands

Tel: (31)2356-81-300/Fax: (31)2356-81-388

### OMRON ELECTRONICS LLC

1 East Commerce Drive, Schaumburg, IL

60173

U.S.A.

Tel: (1)847-843-7900/Fax: (1)847-843-8568

### OMRON ASIA PACIFIC PTE. LTD.

83 Clemenceau Avenue,

#11-01, UE Square,

239920 Singapore

Tel: (65)6835-3011/Fax: (65)6835-2711

### OMRON (CHINA) CO., LTD.

Room 2211, Bank of China Tower,

200 Yin Cheng Road (M)

Shanghai, 200120 China

Tel: (86)21-5037-2222/Fax: (86)21-5037-

2200